

Multilayer Suppressors and Inductors

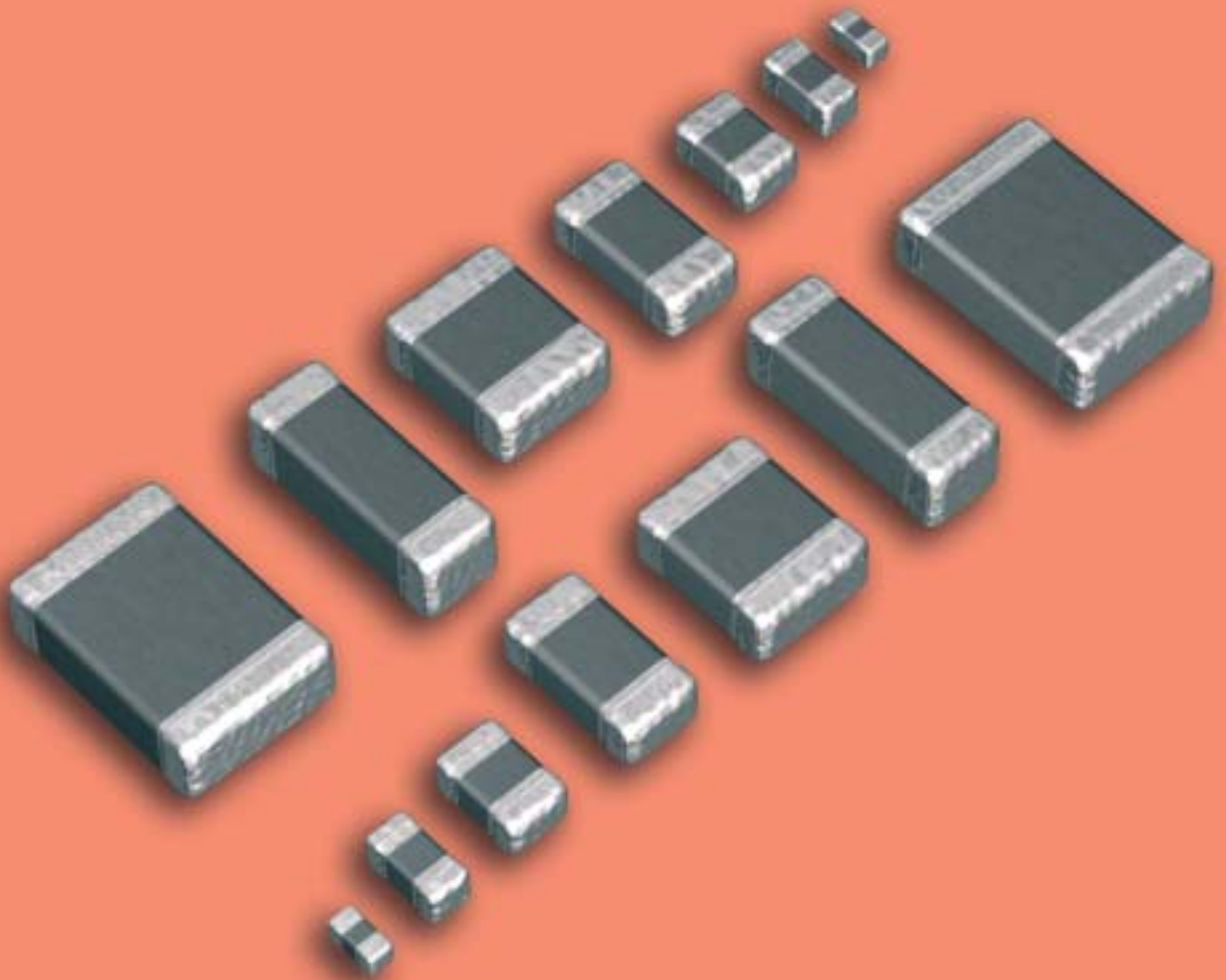

Multilayer Suppressors and Inductors

Contents

Introduction	3
Multilayer Suppressors	
Features	4
Applications	5
Type Number structure	6
Sizes	6
Product range	7
Impedance characteristics	9
Reliability and Quality Control	15
Multilayer Inductors	
Features	16
Applications	17
Type Number structure	18
Sizes	18
Product range	19
Inductance characteristics	21
Reliability and Quality Control	29
Soldering	30
Recommended solder lands	30
Packing	32
Storage Requirements	34

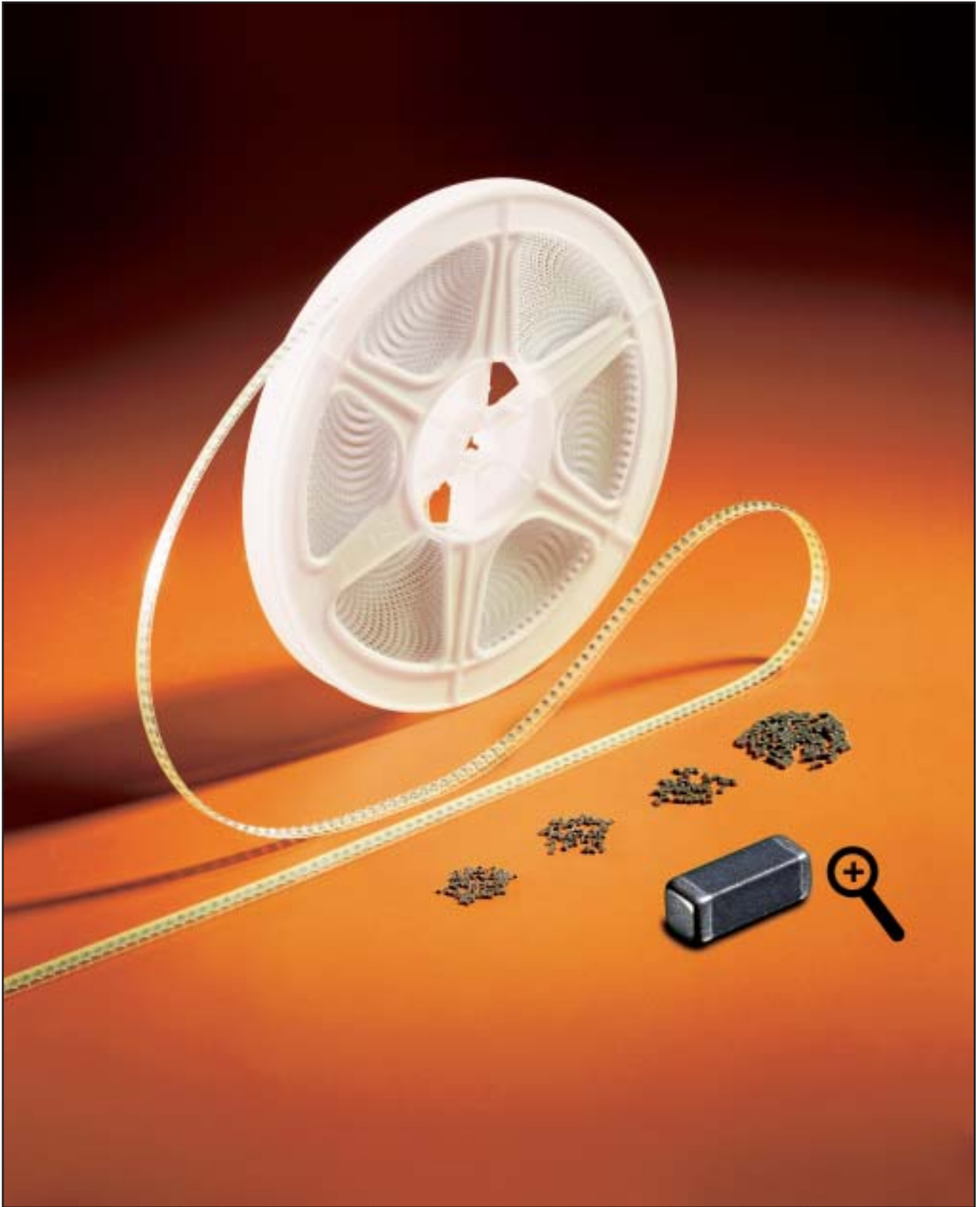

Introduction

FERROXCUBE extends its range of multilayer products by completing the range of multilayer suppressors and introducing multilayer inductors. These ferrite chip beads combine magnetic materials with multilayer and thick film technology.

Multilayer products are truly miniature components and have connecting surfaces that solder directly to the solder lands on a substrate. The multilayer electrode and terminations are made of silver to ensure high electrical conductivity. The electrode is embedded in a ferrite monolithic structure, which provides a good magnetic shielding and makes it very appropriate for high density mounting.

Multilayer products are made in EIA standard sizes, which facilitates the use of existing automatic pick-and-place machines. They can be soldered with a wave or reflow soldering process on PC board assemblies. The products are supplied in standard tapes and reels.

These high quality components are manufactured with advanced production techniques, with a background knowledge of the product and a well-established and disciplined approach to quality control.

The size, performance and reliability of multilayer components make them very attractive for a wide range of applications. For example, where the application demands a compact electronic circuit on a small board, multilayer suppressors offer the designer a powerful and reliable

method of noise attenuation between electronic circuits with negligible effect on the actual signals.

With this complete range of multilayer products FERROXCUBE now offers a wide range of components specially designed for surface mounting. We can also offer technological support on the use of components.



Multilayer Suppressors

Features

- Monolithic structure for closed magnetic path and high reliability
- Standard EIA and EIAJ sizes:
0402, 0603, 0805, 1206, 1210, 1806 and 1812
- High impedance per volume which leads to effective high density circuits
- Suitable for wave and reflow soldering
- Wide range of impedance values
- Superior physical properties
- Available in standard EIA and EIAJ tape-and-reel
- Operating temperature -40°C to $+125^{\circ}\text{C}$
- 100% sorting out on impedance



Applications

Multilayer suppressors are a powerful solution for EMI/RFI attenuation for electronic equipment. Supplied in seven standard sizes (0402, 0603, 0805, 1206, 1210, 1806 and 1812), they have impedances between 6 and 2000 Ω at 100MHz.

When installed in series with signal and/or power circuits high frequency noise is suppressed. There is no need for ground termination, which makes these devices very suitable for circuits with difficult ground. Typical suppression frequencies range from 10MHz to 1000MHz and rated currents are 0.1 and 6 A.

Multilayer suppressors are specially designed to reduce noise in low impedance circuits while keeping the signal free from distortion. This is because at the interfering frequencies these components behave resistive. The high frequency noise is converted into heat rather than reflected to the source. This dissipation prevents ringing and parasitic oscillations.

These characteristics can be used for many different purposes:

- Absorption of generated noise.
- In digital signals from high speed clock oscillators, for filtering and wave-shape correction.
- Prevention of high frequency interference entering circuit electronics.

Main applications areas for multilayer suppressors are:

- computer and peripheral equipment: mother board, notebook, CD-Rom, DVD-Rom, CD-RW, scanner, hard disc, VGA card, sound card, LCD monitor, printer, PC server thumb drive, PCMCIA card, graphic card, etc.
- network: LAN card, hub, switcher, router set top box, etc.
- telecom: cell phone, ADSL, wired modem, cable modem, ISDN, GPS satellite receiver, etc.
- consumer: walkman, walkdisc, digital still camera (DSC), sound system, HDTV, projector, DVD player, VCD player, tuner for TV, cable modem, etc.

To help designers in the trial and error process of finding the most suitable suppression component, we offer a sample box with a selection of products.

Ordering code: SAMPLEBOX12



Type Number structure

- **MultiLayer Suppressor:** MLS 0603-4S4-600

1 2 3 4

1. Product type
2. Size
3. Internal code
4. Impedance value

- **MultiLayer Power bead:** MLP 1806-151

1 2 3

1. Product type
2. Size
3. Impedance value

- **MultiLayer Narrow band:** MLN 1206-201

1 2 3

1. Product type
2. Size
3. Impedance value

Impedance value

- Expressed in ohm (Ω).
- First two digits are significant figures.
- Last digit is the number of zeros to follow.
- Examples:

070	7 Ω
600	60 Ω
101	100 Ω
151	150 Ω
152	1500 Ω
102	1000 Ω

Tolerance:

Standard products have a tolerance on impedance of $\pm 25\%$.

Sizes

Standard sizes for multilayer suppressors MLS, MLP, MLN are given in the table below.

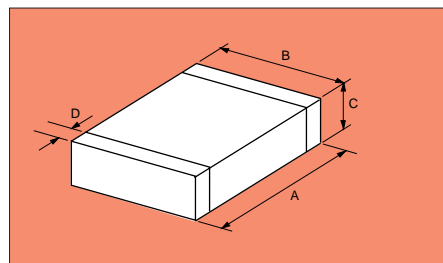

Size	A(mm)	B(mm)	C(mm)	D(mm)
0402	1.0 \pm 0.15	0.50 \pm 0.15	0.50 \pm 0.15	0.25 \pm 0.15
0603	1.6 \pm 0.20	0.80 \pm 0.15	0.80 \pm 0.15	0.40 \pm 0.20
0805	2.0 \pm 0.20	1.25 \pm 0.20	0.90 \pm 0.20	0.50 \pm 0.30
1206	3.2 \pm 0.20	1.60 \pm 0.20	1.10 \pm 0.20	0.50 \pm 0.30
1210	3.2 \pm 0.20	2.50 \pm 0.20	1.30 \pm 0.20	0.50 \pm 0.30
1806	4.5 \pm 0.25	1.60 \pm 0.20	1.60 \pm 0.20	0.50 \pm 0.30
1812	4.5 \pm 0.25	3.20 \pm 0.20	1.50 \pm 0.20	0.50 \pm 0.30

Multilayer Suppressor - MLS

General Purpose

Type Number	Size	Z \pm 25% at 100 MHz (Ω)	R _{DCmax} (Ω)	I _{max} (mA)
MLS0402-4S4-060	0402	6	0.05	500
MLS0402-4S4-100	0402	10	0.05	500
MLS0402-4S4-400	0402	40	0.3	300
MLS0402-4S4-800	0402	80	0.4	200
MLS0402-4S4-121	0402	120	0.5	200
MLS0402-4S4-241	0402	240	0.5	200
MLS0402-4S4-481	0402	480	0.8	100
MLS0603-4S4-110	0603	11	0.05	500
MLS0603-4S4-190	0603	19	0.08	500
MLS0603-4S7-300	0603	30	0.1	400
MLS0603-4S7-400	0603	40	0.1	400
MLS0603-4S7-600	0603	60	0.1	300
MLS0603-4S7-800	0603	80	0.15	300
MLS0603-4S7-101	0603	100	0.25	250
MLS0603-4S7-121	0603	120	0.3	250
MLS0603-4S7-151	0603	150	0.3	250
MLS0603-4S7-221	0603	220	0.3	200
MLS0603-4S7-301	0603	300	0.35	230
MLS0603-4S7-451	0603	450	0.5	200
MLS0603-4S7-601	0603	600	0.45	210
MLS0603-4S7-751	0603	750	0.7	200
MLS0603-4S7-102	0603	1000	0.6	190
MLS0603-4S4-152	0603	1500	1	50
MLS0805-4S4-070	0805	7	0.1	600
MLS0805-4S4-090	0805	9	0.1	600
MLS0805-4S4-110	0805	11	0.1	600
MLS0805-4S4-170	0805	17	0.1	500
MLS0805-4S4-300	0805	30	0.1	600
MLS0805-4S4-600	0805	60	0.1	600
MLS0805-4S7-700	0805	70	0.15	500
MLS0805-4S7-800	0805	80	0.15	500
MLS0805-4S7-121	0805	120	0.2	400
MLS0805-4S7-151	0805	150	0.25	200
MLS0805-4S7-221	0805	220	0.3	300
MLS0805-4S7-301	0805	300	0.3	200
MLS0805-4S7-401	0805	400	0.3	300
MLS0805-4S7-501	0805	500	0.4	300
MLS0805-4S7-601	0805	600	0.3	200
MLS0805-4S4-751	0805	750	0.5	200
MLS0805-4S7-102	0805	1000	0.5	200
MLS0805-4S7-152	0805	1500 ⁽¹⁾	0.6	200
MLS0805-4S4-202	0805	2000	0.8	100

Type Number	Size	Z \pm 25% at 100 MHz (Ω)	R _{DCmax} (Ω)	I _{max} (mA)
MLS1206-4S4-190	1206	19	0.05	600
MLS1206-4S4-260	1206	26	0.05	600
MLS1206-4S4-300	1206	30	0.1	600
MLS1206-4S4-500	1206	50	0.1	500
MLS1206-4S4-600	1206	60	0.1	500
MLS1206-4S4-700	1206	70	0.1	600
MLS1206-4S4-900	1206	90	0.15	500
MLS1206-4S4-121	1206	120	0.15	500
MLS1206-4S4-151	1206	150	0.15	500
MLS1206-4S4-201	1206	200	0.2	400
MLS1206-4S4-401	1206	400	0.2	400
MLS1206-4S4-501	1206	500	0.2	400
MLS1206-4S4-601	1206	600	0.3	400
MLS1206-4S7-102	1206	1000	0.4	200
MLS1206-4S7-122	1206	1200 ⁽¹⁾	0.4	200
MLS1206-4S7-202	1206	2000 ⁽²⁾	0.6	200
MLS1210-4S4-320	1210	32	0.2	500
MLS1210-4S4-600	1210	60	0.2	500
MLS1210-4S4-900	1210	90	0.2	500
MLS1806-4S4-500	1806	50	0.2	600
MLS1806-4S4-600	1806	60	0.2	600
MLS1806-4S4-800	1806	80	0.1	600
MLS1806-4S4-101	1806	100	0.3	500
MLS1806-4S4-151	1806	150	0.2	500
MLS1806-4S4-171	1806	170	0.3	500
MLS1812-4S4-700	1812	70	0.3	500
MLS1812-4S4-121	1812	120	0.3	500

(1) at 50 MHz

(2) at 30 MHz

- R_{DC}: Resistance of component for DC current.
- Maximum rated current: measure of current capacity of the component. When the maximum rated current is applied, temperature rise shall not exceed 20°C.
- Standard tolerance on impedance is \pm 25%.
- Other tolerances can be provided upon request.
- Operating temperature: -40°C to +125°C.

Multilayer Power Beads - MLP

High Current

Type Number	Size	Z \pm 25% at 100 MHz (Ω)	R _{DCmax} (Ω)	I _{max} (mA)
MLP0603-110	0603	11	0.02	4000
MLP0603-250	0603	25	0.03	3000
MLP0603-400	0603	40	0.035	3000
MLP0603-600	0603	60	0.04	2500
MLP0603-121	0603	120	0.05	1800
MLP0603-301	0603	300	0.1	2000
MLP0603-501	0603	500	0.15	1500
MLP0603-601	0603	600	0.2	1000
MLP0603-102	0603	1000	0.25	800
MLP0805-110	0805	11	0.01	6000
MLP0805-170	0805	17	0.02	5000
MLP0805-300	0805	30	0.02	4000
MLP0805-600	0805	60	0.03	3000
MLP0805-800	0805	80	0.04	3000
MLP0805-121	0805	120	0.04	3000
MLP0805-201	0805	200	0.05	2500
MLP0805-301	0805	300	0.08	2000
MLP0805-601	0805	600	0.1	2000
MLP0805-102	0805	1000	0.12	1500
MLP1206-190	1206	19	0.015	6000
MLP1206-320	1206	32	0.015	4000
MLP1206-500	1206	50	0.02	4000
MLP1206-700	1206	70	0.025	3000
MLP1206-800	1206	80	0.025	3000
MLP1206-101	1206	100	0.03	2500
MLP1206-301	1206	300	0.06	2000
MLP1206-601	1206	600	0.1	1800
MLP1206-102	1206	1000 ⁽¹⁾	0.15	1500
MLP1206-122	1206	1200 ⁽¹⁾	0.18	1500
MLP1206-152	1206	1500 ⁽¹⁾	0.2	1200
MLP1210-600	1210	60	0.025	4000
MLP1210-900	1210	90	0.025	3000
MLP1806-500	1806	50	0.02	6000
MLP1806-600	1806	60	0.02	5000
MLP1806-800	1806	80	0.025	4000
MLP1806-151	1806	150	0.1	2000
MLP1812-700	1812	70	0.03	6000
MLP1812-121	1812	120	0.03	4000

⁽¹⁾ at 50 MHz

Multilayer Narrow Band - MLN

Narrow Band

Type Number	Size	Z \pm 25% at 100 MHz (Ω)	R _{DCmax} (Ω)	I _{max} (mA)
MLN0603-060	0603	6	0.05	500
MLN0603-100	0603	10	0.07	400
MLN0603-400	0603	40	0.30	300
MLN0603-800	0603	80	0.40	300
MLN0603-121	0603	120	0.40	300
MLN0603-241	0603	240	0.40	200
MLN0603-301	0603	300	0.50	200
MLN0603-481	0603	480	0.60	150
MLN0603-601	0603	600	0.60	100
MLN0805-060	0805	6	0.07	800
MLN0805-110	0805	11	0.10	700
MLN0805-260	0805	26	0.20	600
MLN0805-320	0805	32	0.20	600
MLN0805-600	0805	60	0.30	500
MLN0805-750	0805	75	0.30	500
MLN0805-900	0805	90	0.30	500
MLN0805-121	0805	120	0.40	400
MLN0805-151	0805	150	0.40	400
MLN0805-171	0805	170	0.50	400
MLN0805-221	0805	220	0.50	300
MLN0805-301	0805	300	0.50	300
MLN0805-401	0805	400	0.50	300
MLN0805-501	0805	500	0.50	200
MLN0805-601	0805	600	0.50	200
MLN0805-102	0805	1000	0.60	100
MLN0805-122	0805	1200	0.70	100
MLN0805-152	0805	1500	0.70	100
MLN1206-320	1206	32	0.20	600
MLN1206-600	1206	60	0.30	500
MLN1206-800	1206	80	0.30	500
MLN1206-900	1206	90	0.30	500
MLN1206-121	1206	120	0.40	400
MLN1206-151	1206	150	0.40	400
MLN1206-201	1206	200	0.50	300
MLN1206-221	1206	220	0.50	300
MLN1206-351	1206	350	0.60	300
MLN1206-401	1206	400	0.60	300
MLN1206-601	1206	600	0.80	300
MLN1206-122	1206	1200	1.00	200

Impedance characteristics

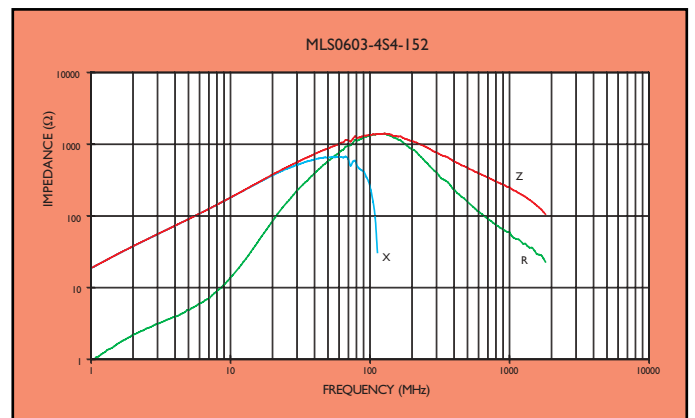
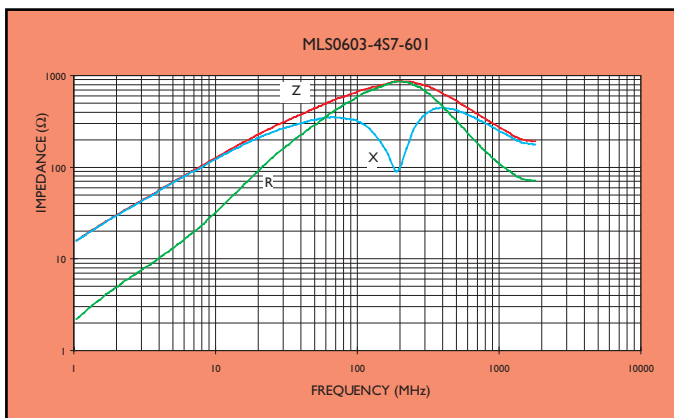
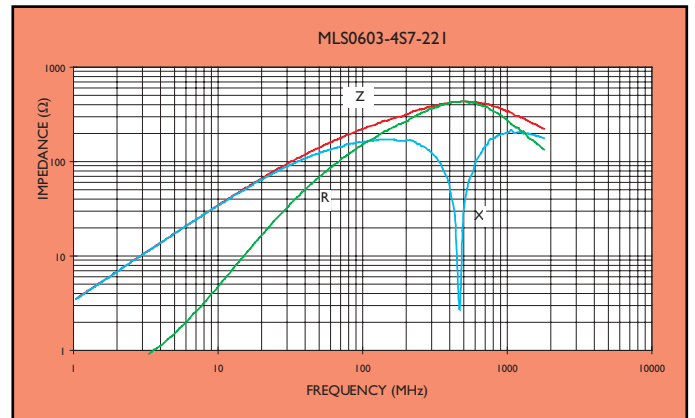
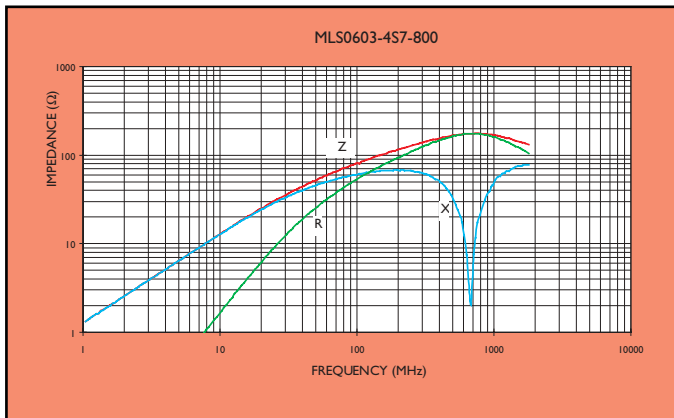
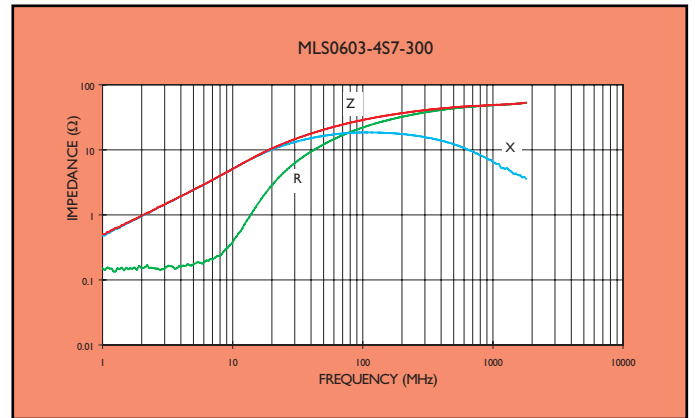
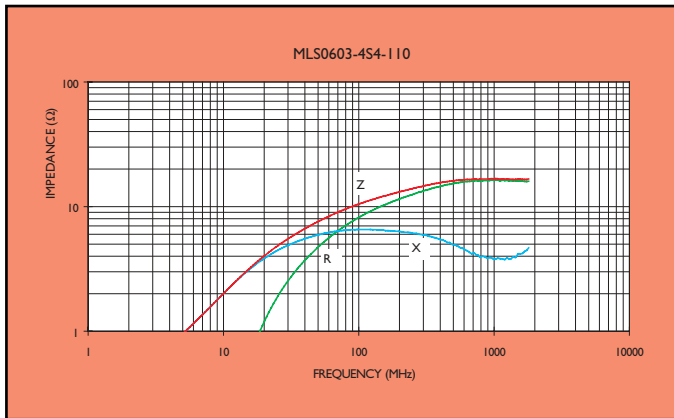
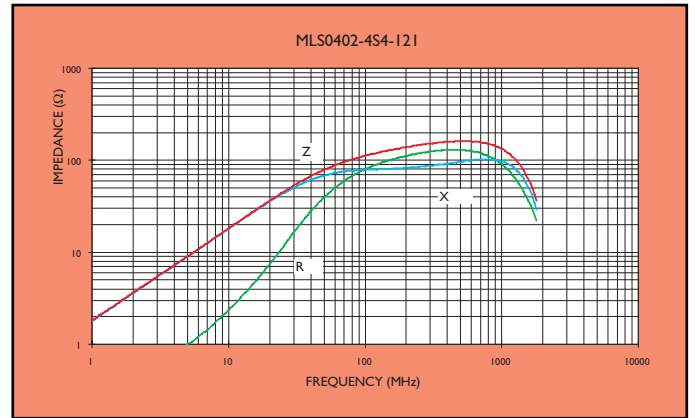
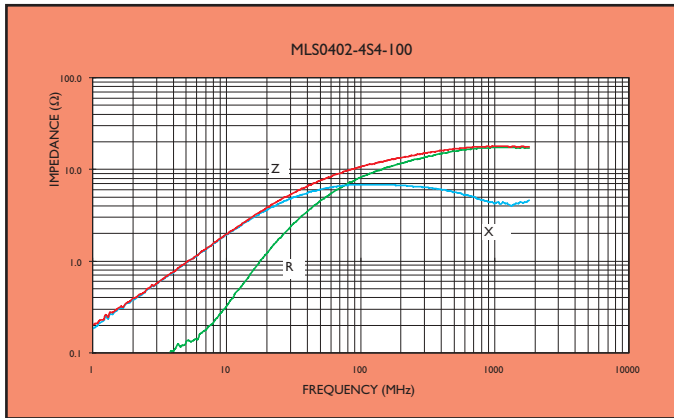

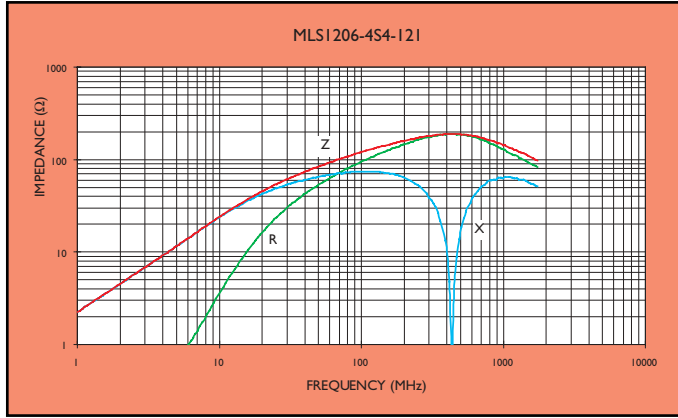
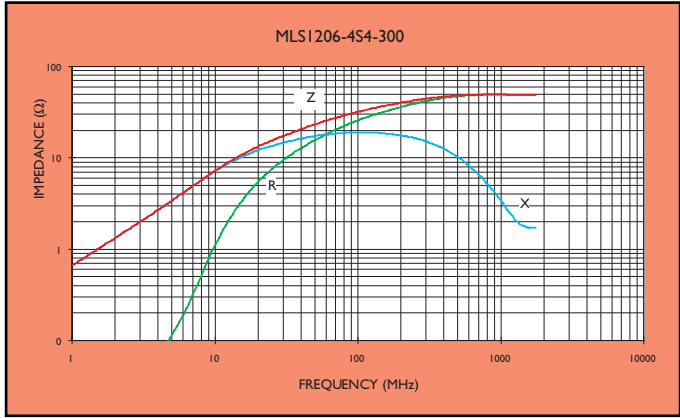
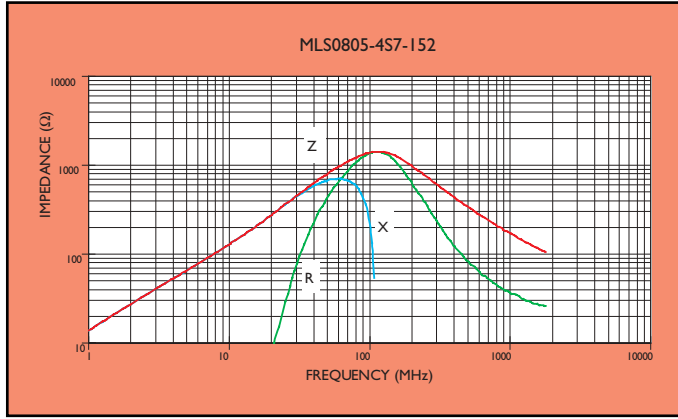
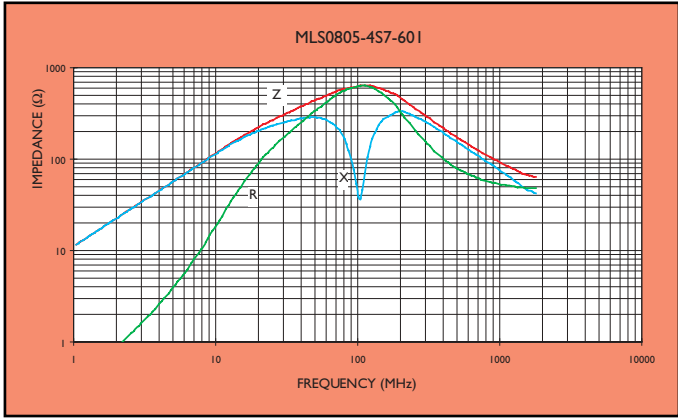
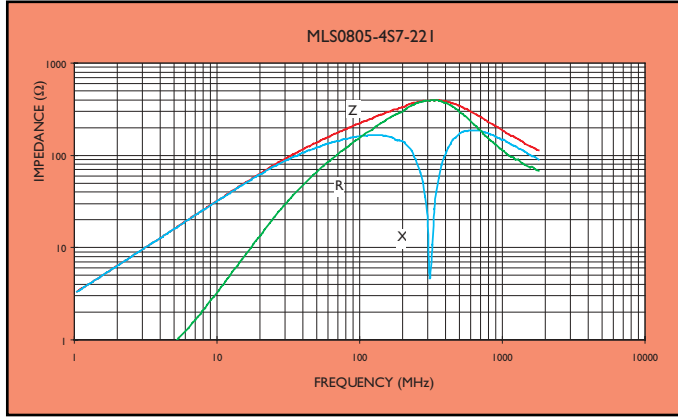
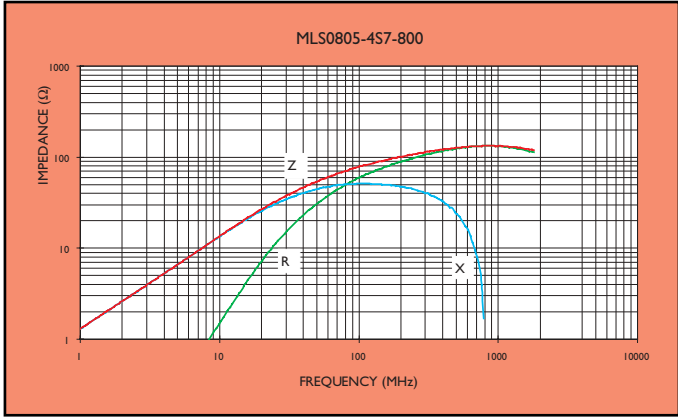
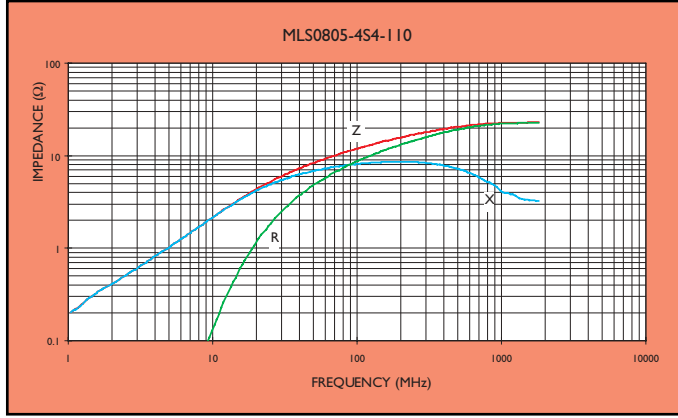
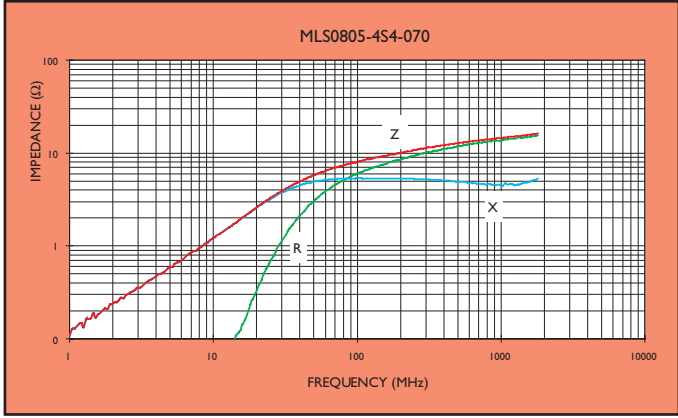

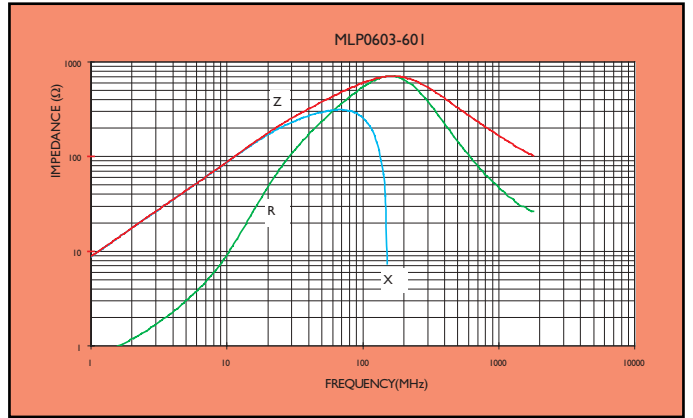
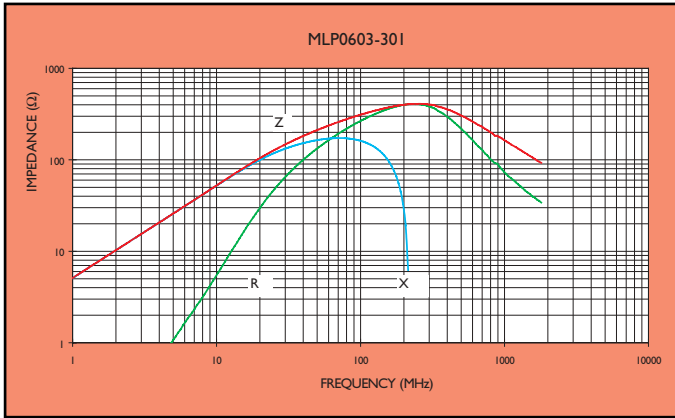
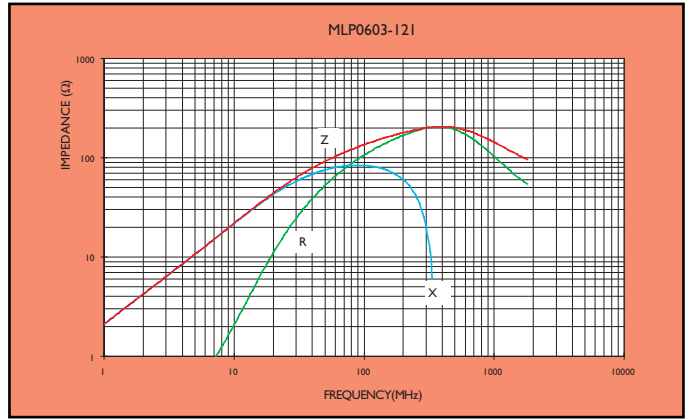
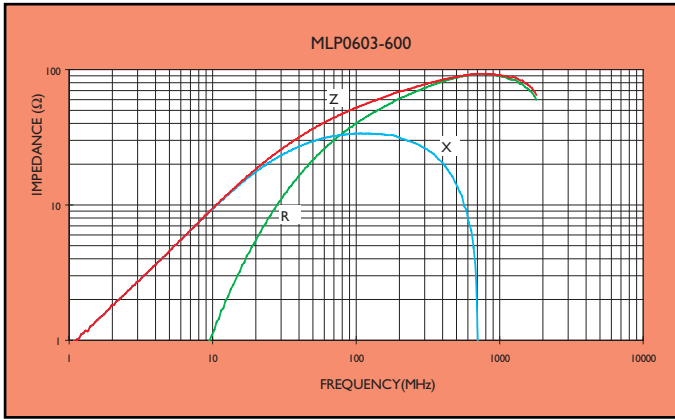
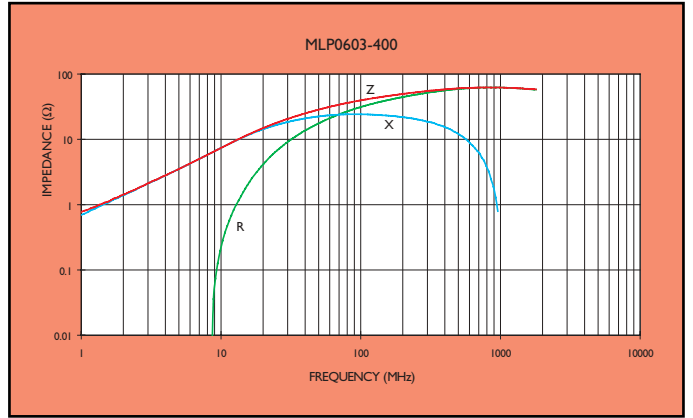
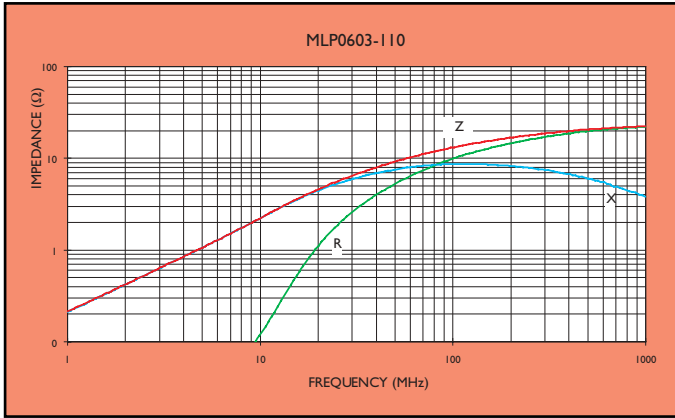
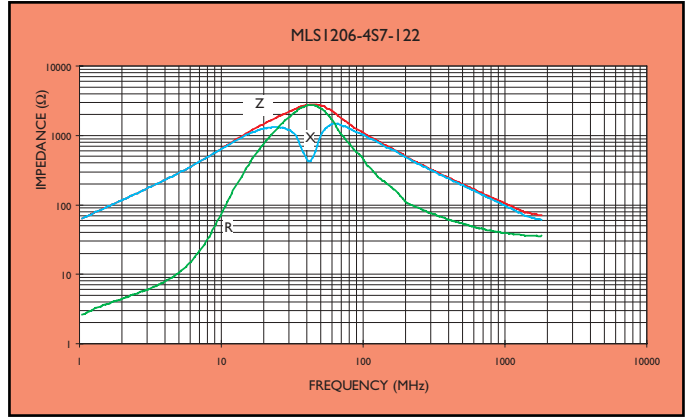
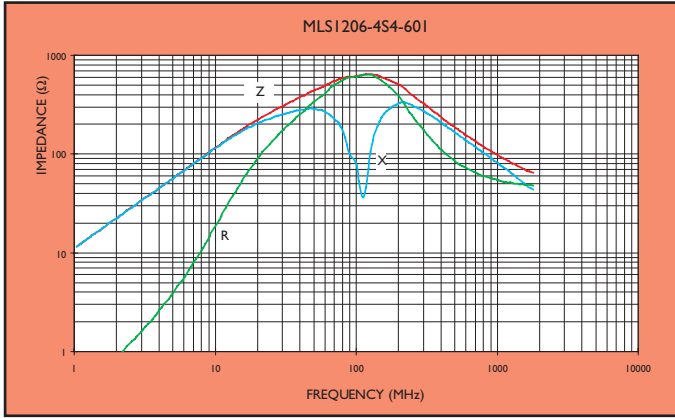

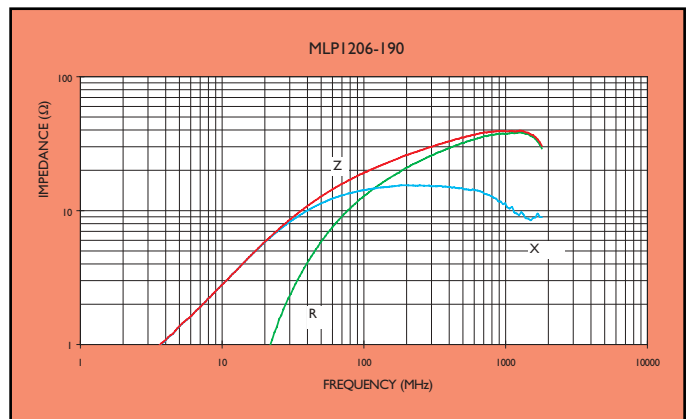
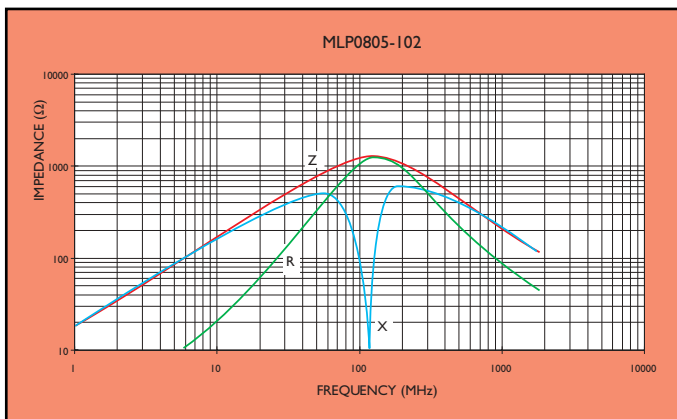
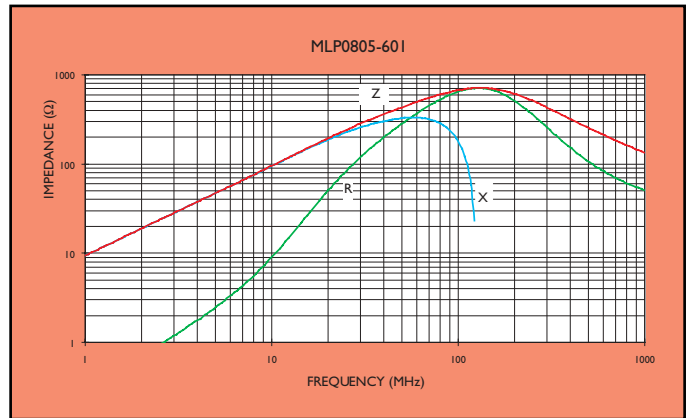
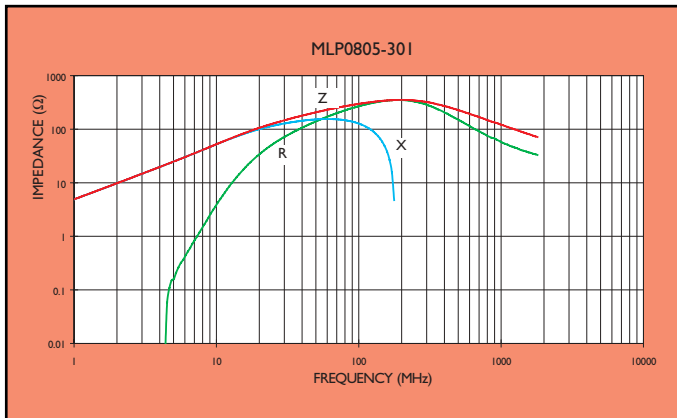
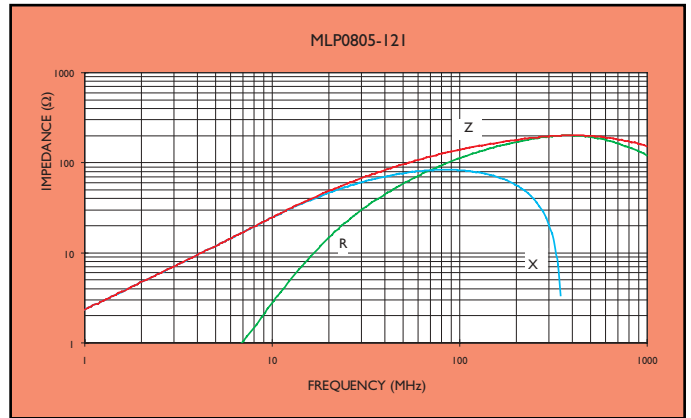
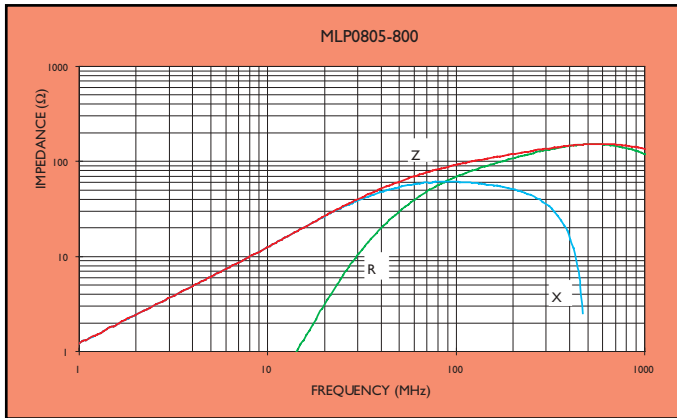
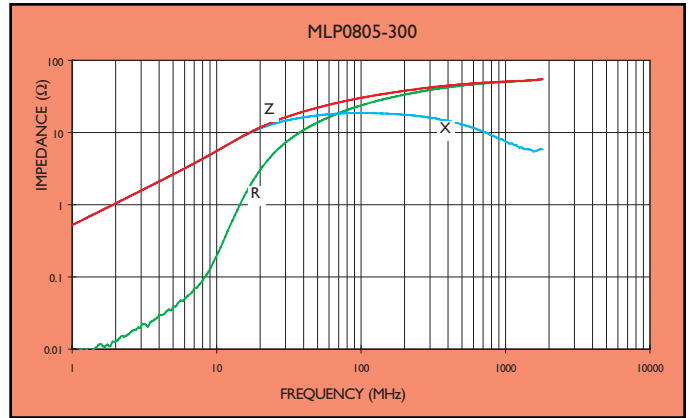
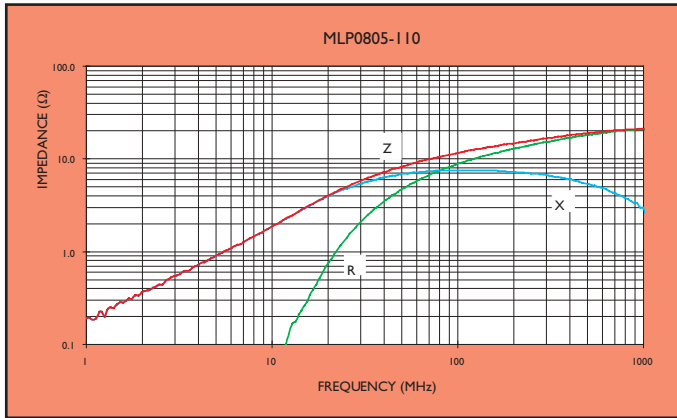

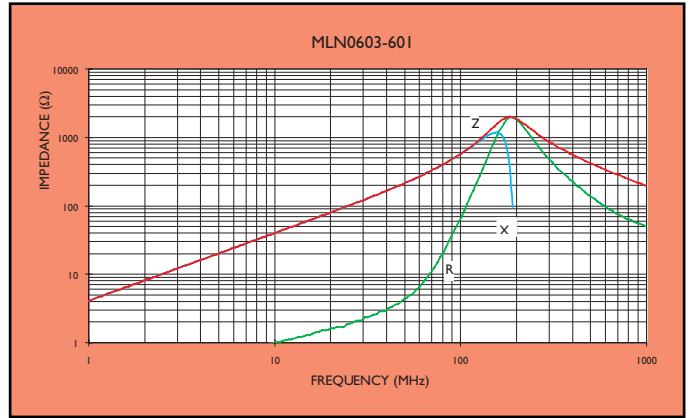
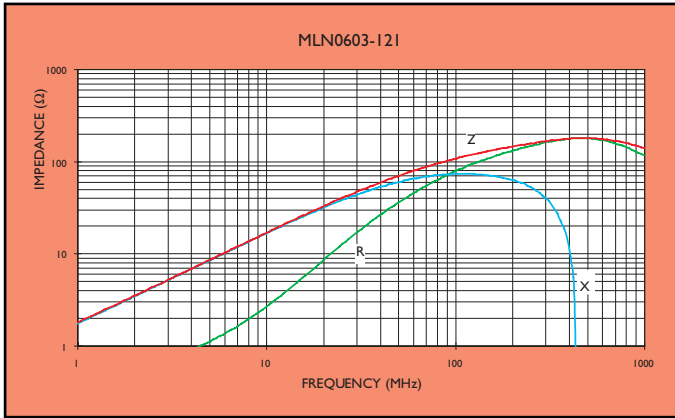
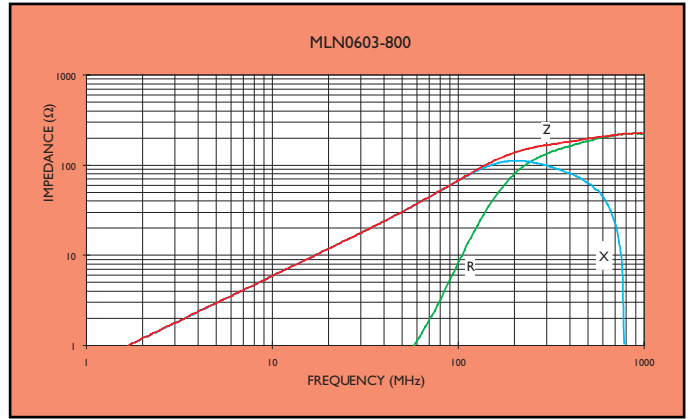
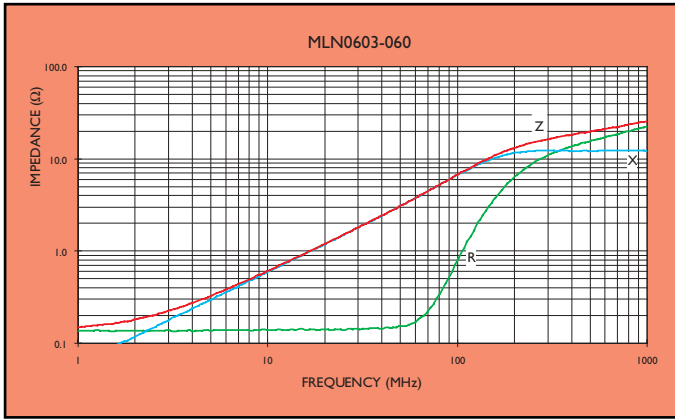
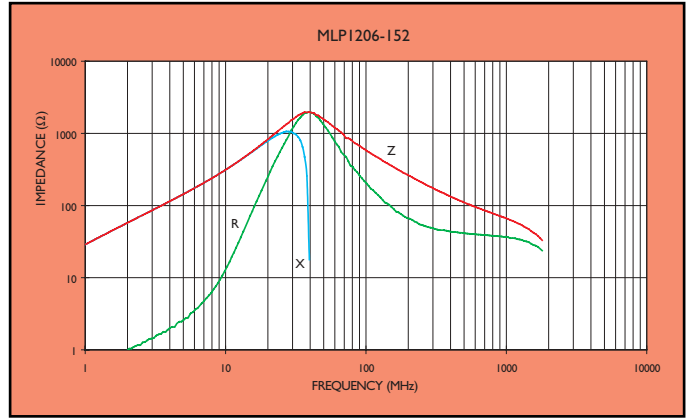
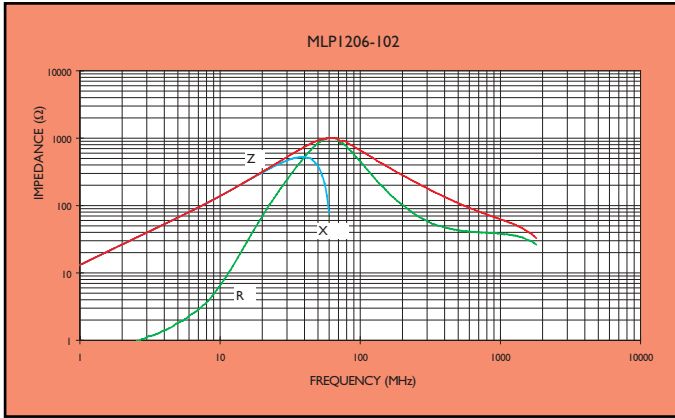
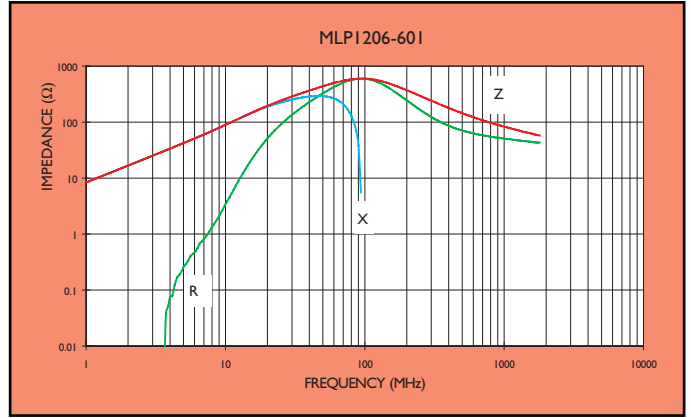
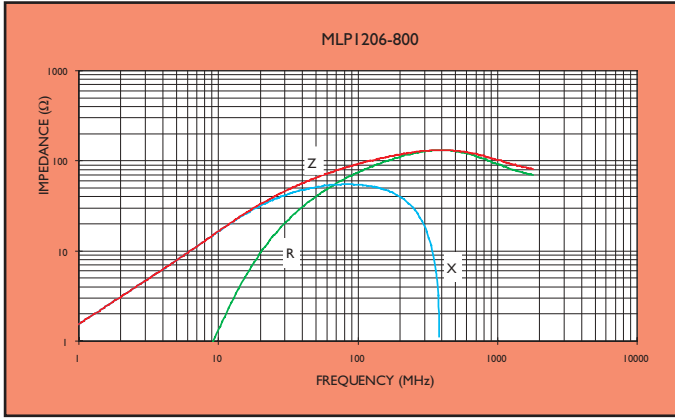

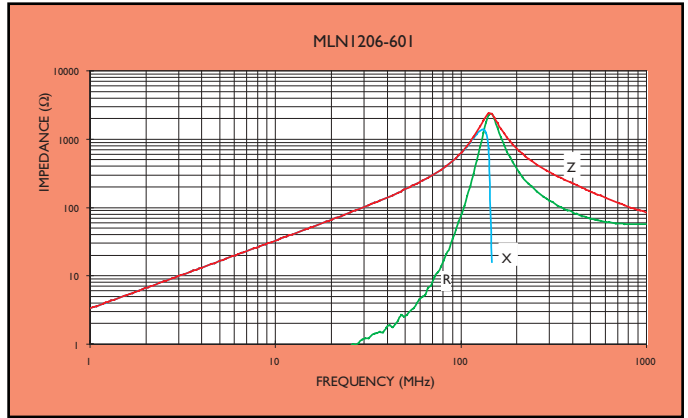
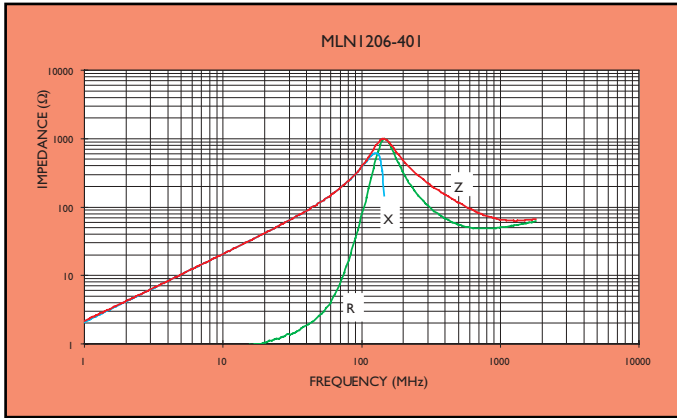
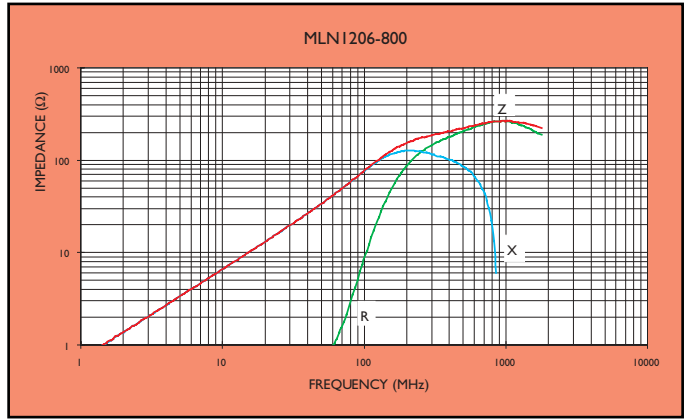
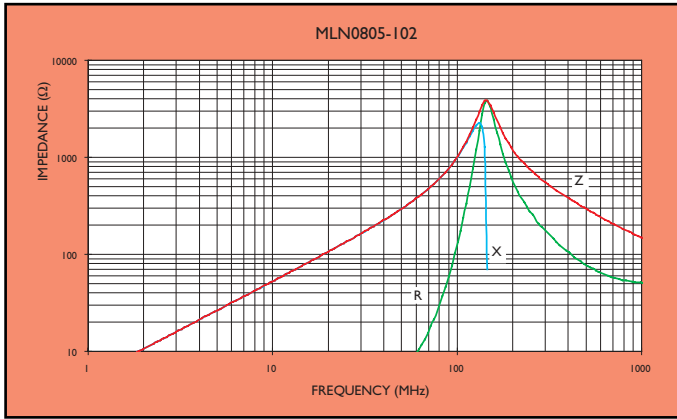
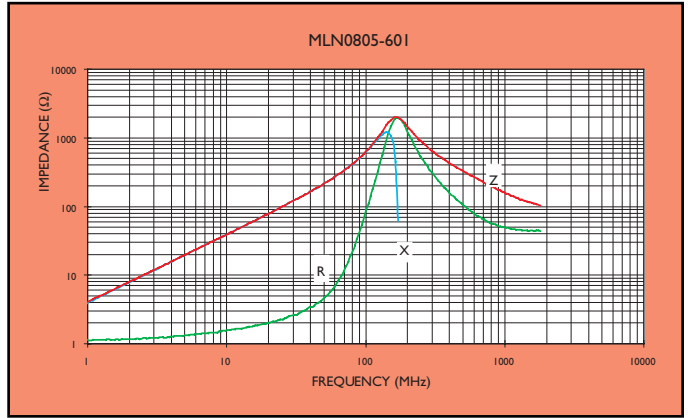
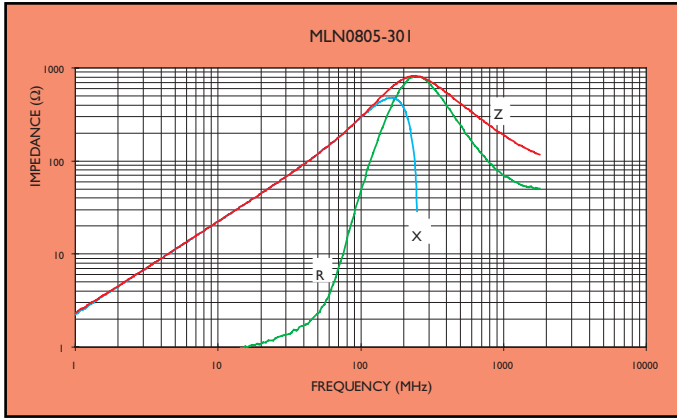
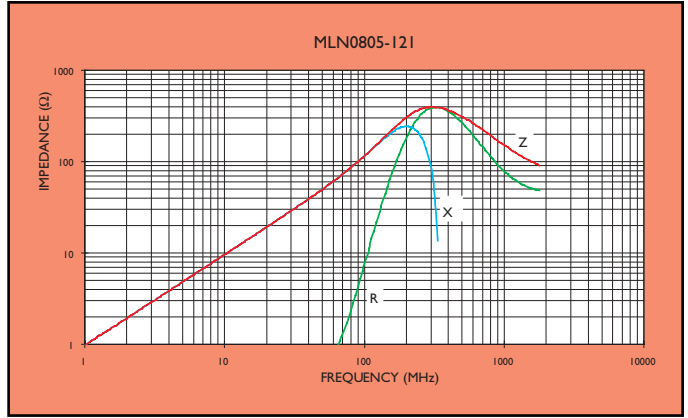
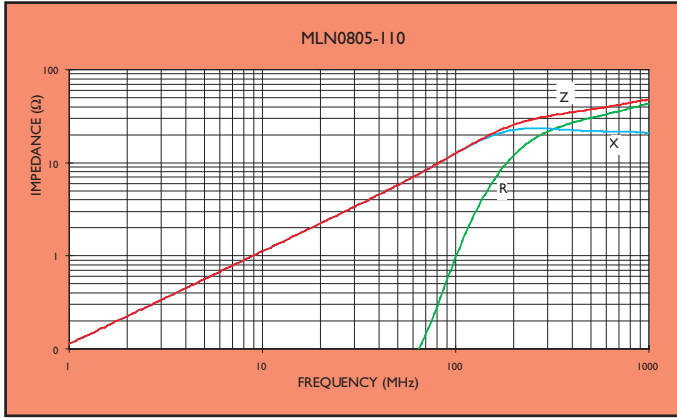

Reliability and Quality Controls

FERROXCUBE multilayer suppressors are submitted to extensive tests to ensure high quality, high reliability and complete customer satisfaction. A brief description is given below.

Electrical test

The inductive components are tested 100% for impedance and R_{DC} by automatic sorting machines. Samples from each lot of products are double-checked by QA personnel. All components shall have electrical properties within the tolerances specified in the product specification.

External visual inspection

Samples are inspected under 10 to 30 x magnification by microscope for any physical defect, such as chips, cracking, delamination, over-plating, etc.. No damage shall be found in the products.

Life test

Samples are tested at 85°C with maximum rated current for 1000 hours, and 20% relative humidity. After the test, no physical and mechanical damage shall be observed, and the impedance shall not have changed by more than 20% from the initial value.

Loaded humidity test

The components are placed in a testing chamber at 40°C and 90% relative humidity. Then 100% of the rated current is applied to the components for 1000 hrs. No physical and mechanical damage shall be observed, and the impedance shall not have changed by more than 20% from the initial value.

Thermal shock test

The components are subjected to 100 temperature cycles between -40°C and +85°C. Kept stabilised for 30 minutes each. No physical and mechanical damage shall be observed, and the impedance shall not have changed by more than 20% from the initial value.

Vibration test

The components are subjected to vibrations with a frequency range of 10 to 55 Hz with 1.5 mm amplitude, in three directions for 2 hours each. No physical and mechanical damage shall be observed, and the impedance shall not have changed by more than 20% from the initial values.

Bending test

The chips are soldered on a PCB and subjected to one bend of 2 mm. No physical and mechanical damage shall be observed.

Solderability test

The chips are wetted with Type R rosin flux, then dipped into an H63A eutectic solder pot at 230°C for 3 seconds. As a result more than 90% of each termination surface shall be covered by new solder.

Resistance to soldering heat

The chips are dipped in flux first, then dipped into a solder pot at 260°C for 10 seconds. There shall not be any physical damage to the chips. More than 75% of each terminal surface shall be covered by new solder.

Terminal strength

The chips are lead attached to a wire with solder and suspended for 30 seconds with a weight according to the chip size (0.2 kg for 0402, 0.5 kg for 0603, 1 kg for 0805, and 2 kg for larger). No damage shall be observed after the test.

Multilayer Inductors

Features

- Monolithic structure for closed magnetic path and high reliability.
- Standard EIA and EIAJ sizes: 0402, 0603, 0805, 080505, 1206.
- This multilayer chip inductor results in magnetic shielding: the absence of leakage flux makes it most suitable for high density mounting.
- Suitable for wave and reflow soldering.
- Wide range of inductance values.
- Superior physical properties.
- Available in standard EIA and EIAJ tape-and-reel.
- Operating temperature -40°C to $+125^{\circ}\text{C}$.
- 100% sorting out on inductance.



Applications

Our range of multilayer chip inductors offers magnetic shielding, in five standard sizes (0402, 0603, 0805, 080505 and 1206), which are specially design for electronic products. It offers minimum flux leakage thus eliminating cross talk. They have inductances between 1 nH and 18 μ H.



Main applications areas for multilayer inductors are:

- computer and peripheral equipment: mother board, notebook, CD-Rom, DVD-Rom, CD-RW, scanner, hard disc, VGA card, sound card, LCD monitor, printer, PC server thumb drive, PCMCIA card, graphic card, etc.
- network: LAN card, hub, switcher, router set top box, etc.
- telecom: cell phone, ADSL, wired modem, cable modem, ISDN, GPS satellite receiver, etc.
- consumer: walkman, walkdisc, digital still camera (DSC), sound system, HDTV, projector, DVD player, VCD player, tuner for TV, cable modem, etc.

Main high frequency application for multilayer inductor MLH are:

- cell phone, dect phone, wireless LAN card, wireless micro-phone, TV tuner, RF receiver, cable modem, RF amplifier, security remote control, wireless mouse, wireless keyboard pager, set top box.

To help designers in the trial and error process of finding the most suitable component, we offer a sample box with a selection of products.

Ordering code: SAMPLEBOX13



Type Number structure

• **MultiLayer Inductor:** $\frac{\text{MLI}}{1} \frac{0805\text{-R68}}{2} \frac{\text{-10}}{3} \frac{}{4}$

1. Product type
2. Size
3. Inductance value
4. Tolerance (%)

• **MultiLayer inductor High frequency:** $\frac{\text{MLH}}{1} \frac{0402\text{-4N7}}{2} \frac{\text{-03}}{3} \frac{}{4}$

1. Product type
2. Size
3. Inductance value
4. Tolerance

Inductance value

- Expressed in nH or μH
- Three different kind to express:

4N7 4.7 nH

82N 82 nH

R10 0.10 μH

1R8 1.8 μH

820 82 μH

151 150 μH

Tolerance:

- Last two digits are tolerance: '05', '10' or '20' in %
- In MLH '03' = ± 0.3 nH in absolute value, '5' = $\pm 5\%$ in percentage.

Sizes

Standard sizes for multilayer inductors MLI and MLH are given in the tables below.

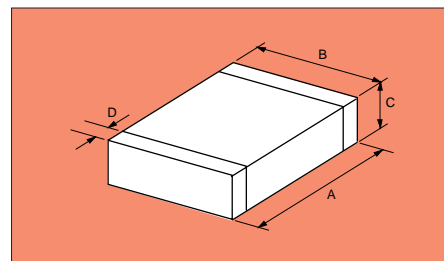

Multilayer Inductor MLI

Size	A(mm)	B(mm)	C(mm)	D(mm)
0603	1.6 ± 0.15	0.80 ± 0.15	0.80 ± 0.15	0.30 ± 0.20
0805	2.0 ± 0.20	1.25 ± 0.20	0.90 ± 0.20	0.50 ± 0.30
080505	2.0 ± 0.20	1.25 ± 0.20	1.25 ± 0.20	0.50 ± 0.30

Multilayer Inductor MLH

Size	A(mm)	B(mm)	C(mm)	D(mm)
0402	1.0 ± 0.15	0.50 ± 0.15	0.50 ± 0.15	0.25 ± 0.15
0603	1.6 ± 0.20	0.80 ± 0.15	0.80 ± 0.15	0.30 ± 0.20
0805	2.0 ± 0.20	1.25 ± 0.20	*	0.50 ± 0.30

* NOTE:

for types L < 180 nH 0.90 ± 0.20

for types L ≥ 180 nH 1.20 ± 0.30

Multilayer Inductors - MLI

General Purpose

Type Number	L(μ H)	L tol.	Q min	L,Q test f (MHz)	SRF min (MHz)	R _{DC} max (Ω)	I max (mA)
MLI0603-47N-20	0.047	$\pm 20\%$	20	50	260	0.3	50
MLI0603-68N-20	0.068	$\pm 20\%$	20	50	250	0.3	50
MLI0603-82N-20	0.082	$\pm 20\%$	20	50	245	0.3	50
MLI0603-R10-10	0.1	$\pm 10\%$	30	25	240	0.5	50
MLI0603-R12-10	0.12	$\pm 10\%$	30	25	205	0.5	50
MLI0603-R15-10	0.15	$\pm 10\%$	30	25	180	0.6	50
MLI0603-R18-10	0.18	$\pm 10\%$	30	25	165	0.6	50
MLI0603-R22-10	0.22	$\pm 10\%$	30	25	150	0.8	50
MLI0603-R27-10	0.27	$\pm 10\%$	30	25	136	0.8	50
MLI0603-R33-10	0.33	$\pm 10\%$	30	25	125	0.85	35
MLI0603-R39-10	0.39	$\pm 10\%$	30	25	110	1	35
MLI0603-R47-10	0.47	$\pm 10\%$	30	25	105	1.35	35
MLI0603-R56-10	0.56	$\pm 10\%$	30	25	95	1.55	35
MLI0603-R68-10	0.68	$\pm 10\%$	30	25	85	1.7	35
MLI0603-R82-10	0.82	$\pm 10\%$	30	25	75	2.1	35
MLI0603-1R0-10	1.0	$\pm 10\%$	35	10	65	0.6	25
MLI0603-1R2-10	1.2	$\pm 10\%$	35	10	60	0.8	25
MLI0603-1R5-10	1.5	$\pm 10\%$	35	10	55	0.8	25
MLI0603-1R8-10	1.8	$\pm 10\%$	35	10	50	0.95	25
MLI0603-2R2-10	2.2	$\pm 10\%$	35	10	45	1.15	15
MLI0603-2R7-10	2.7	$\pm 10\%$	35	10	40	1.35	15
MLI0603-3R3-10	3.3	$\pm 10\%$	35	10	38	1.55	15
MLI0603-3R9-10	3.9	$\pm 10\%$	35	10	36	1.7	15
MLI0603-4R7-10	4.7	$\pm 10\%$	35	10	33	2.1	15
MLI0603-5R6-10	5.6	$\pm 10\%$	35	4	22	1.55	5
MLI0603-6R8-10	6.8	$\pm 10\%$	35	4	20	1.7	5
MLI0603-8R2-10	8.2	$\pm 10\%$	30	4	18	2.1	5
MLI0603-100-10	10	$\pm 10\%$	30	2	17	2.55	5
MLI0805-47N-20	0.047	$\pm 20\%$	25	50	320	0.2	300
MLI0805-68N-20	0.068	$\pm 20\%$	25	50	280	0.2	300
MLI0805-82N-20	0.082	$\pm 20\%$	25	50	255	0.2	300
MLI0805-R10-10	0.1	$\pm 10\%$	30	25	235	0.3	250
MLI0805-R12-10	0.12	$\pm 10\%$	30	25	220	0.3	250
MLI0805-R15-10	0.15	$\pm 10\%$	30	25	200	0.4	250
MLI0805-R18-10	0.18	$\pm 10\%$	30	25	185	0.4	250
MLI0805-R22-10	0.22	$\pm 10\%$	30	25	170	0.5	250
MLI0805-R27-10	0.27	$\pm 10\%$	30	25	150	0.5	250
MLI0805-R33-10	0.33	$\pm 10\%$	30	25	145	0.55	250
MLI0805-R39-10	0.9	$\pm 10\%$	30	25	135	0.65	250
MLI0805-R47-10	0.47	$\pm 10\%$	30	25	125	0.65	250
MLI0805-R56-10	0.56	$\pm 10\%$	30	25	115	0.75	150
MLI0805-R68-10	0.68	$\pm 10\%$	30	25	105	0.8	150
MLI0805-R82-10	0.82	$\pm 10\%$	30	25	100	1	150
MLI0805-1R0-10	1.0	$\pm 10\%$	45	10	75	0.45	50
MLI0805-1R2-10	1.2	$\pm 10\%$	45	10	65	0.5	50
MLI0805-1R5-10	1.5	$\pm 10\%$	45	10	60	0.5	50
MLI0805-1R8-10	1.8	$\pm 10\%$	45	10	55	0.6	50
MLI0805-2R2-10	2.2	$\pm 10\%$	45	10	50	0.65	30

Type Number	L(μ H)	L tol.	Q min	L,Q test f (MHz)	SRF min (MHz)	R _{DC} max (Ω)	I max (mA)
MLI080505-2R7-10	2.7	$\pm 10\%$	45	10	45	0.75	30
MLI080505-3R3-10	3.3	$\pm 10\%$	45	10	41	0.8	30
MLI080505-3R9-10	3.9	$\pm 10\%$	45	10	38	0.9	30
MLI080505-4R7-10	4.7	$\pm 10\%$	45	10	35	1	30
MLI080505-5R6-10	5.6	$\pm 10\%$	45	4	32	0.9	15
MLI080505-6R8-10	6.8	$\pm 10\%$	45	4	29	1	15
MLI080505-8R2-10	8.2	$\pm 10\%$	45	4	26	1.1	15
MLI080505-100-10	10	$\pm 10\%$	45	2	24	1.15	15
MLI080505-120-10	12	$\pm 10\%$	45	2	22	1.25	15
MLI080505-150-10	15	$\pm 10\%$	30	1	19	0.8	5
MLI080505-180-10	18	$\pm 10\%$	30	1	18	0.9	5
MLII206-47N-20	0.047	$\pm 20\%$	25	50	320	0.15	300
MLII206-68N-20	0.068	$\pm 20\%$	25	50	280	0.25	300
MLII206-R10-10	0.1	$\pm 10\%$	30	25	235	0.25	250
MLII206-R12-10	0.12	$\pm 10\%$	30	25	220	0.3	250
MLII206-R15-10	0.15	$\pm 10\%$	30	25	200	0.3	250
MLII206-R18-10	0.18	$\pm 10\%$	30	25	185	0.4	250
MLII206-R22-10	0.22	$\pm 10\%$	30	25	170	0.4	250
MLII206-R27-10	0.27	$\pm 10\%$	30	25	150	0.5	250
MLII206-R33-10	0.33	$\pm 10\%$	30	25	145	0.6	250
MLII206-R39-10	0.39	$\pm 10\%$	30	25	135	0.5	200
MLII206-R47-10	0.47	$\pm 10\%$	30	25	125	0.6	200
MLII206-R56-10	0.56	$\pm 10\%$	30	25	115	0.7	150
MLII206-R68-10	0.68	$\pm 10\%$	30	25	105	0.8	150
MLII206-R82-10	0.82	$\pm 10\%$	30	25	100	0.9	150
MLII206-1R0-10	1.0	$\pm 10\%$	45	10	110	0.4	100
MLII206-1R2-10	1.2	$\pm 10\%$	45	10	100	0.5	100
MLII206-1R5-10	1.5	$\pm 10\%$	45	10	90	0.5	80
MLII206-1R8-10	1.8	$\pm 10\%$	45	10	80	0.5	70
MLII206-2R2-10	2.2	$\pm 10\%$	45	10	70	0.6	60
MLII206-2R7-10	2.7	$\pm 10\%$	45	10	70	0.6	60
MLII206-3R3-10	3.3	$\pm 10\%$	45	10	60	0.7	60
MLII206-3R9-10	3.9	$\pm 10\%$	45	10	55	0.8	50
MLII206-4R7-10	4.7	$\pm 10\%$	45	10	50	0.9	50
MLII206-5R6-10	5.6	$\pm 10\%$	45	4	32	0.7	25
MLII206-6R8-10	6.8	$\pm 10\%$	45	4	29	0.8	25
MLII206-8R2-10	8.2	$\pm 10\%$	45	4	26	0.9	25
MLII206-100-10	10	$\pm 10\%$	45	2	24	1	25
MLII206-120-10	12	$\pm 10\%$	45	2	22	1.05	15
MLII206-150-10	15	$\pm 10\%$	35	1	19	0.7	5
MLII206-180-10	18	$\pm 10\%$	35	1	18	0.75	5

- R_{DC}: Resistance of component for DC current.
- Maximum rated current: measure of current capacity of the component.
- Other tolerances can be provided upon request.
- Operating temperature: -40°C to +125°C.

Multilayer Inductors - MLH

High Frequency

Type Number	L (nH) 100 MHz	L tol.	Q min 100 MHz	Q typ 100 MHz	Q typ 800 MHz	SRF min (MHz)	R _{DC} max (Ω)	I max (mA)
MLH0402-1N0-03	1.0	±0.3	8	9	28	6000	0.10	300
MLH0402-1N2-03	1.2	±0.3	8	9	28	6000	0.10	300
MLH0402-1N5-03	1.5	±0.3	8	10	28	6000	0.10	300
MLH0402-1N8-03	1.8	±0.3	8	10	28	6000	0.10	300
MLH0402-2N2-03	2.2	±0.3	8	10	29	6000	0.12	300
MLH0402-2N7-03	2.7	±0.3	8	11	30	6000	0.12	300
MLH0402-3N3-03	3.3	±0.3	8	11	30	5200	0.15	300
MLH0402-3N9-03	3.9	±0.3	8	11	31	5150	0.15	300
MLH0402-4N7-03	4.7	±0.3	8	11	31	4800	0.18	300
MLH0402-5N6-03	5.6	±0.3	8	11	31	4100	0.20	300
MLH0402-6N8-5	6.8	±5%	8	11	33	3800	0.25	300
MLH0402-8N2-5	8.2	±5%	8	12	32	3500	0.25	300
MLH0402-10N-5	10.0	±5%	8	12	32	3300	0.30	300
MLH0402-12N-5	12.0	±5%	8	12	31	2600	0.30	300
MLH0402-15N-5	15.0	±5%	8	12	30	2300	0.40	300
MLH0402-18N-5	18.0	±5%	8	12	29	2050	0.50	300
MLH0402-22N-5	22.0	±5%	8	12	28	1900	0.60	300
MLH0402-27N-5	27.0	±5%	8	12	27	1700	0.70	300
MLH0402-33N-5	33.0	±5%	8	10	25	1550	1.5	200
MLH0402-39N-5	39.0	±5%	8	10	25	1450	1.8	200
MLH0402-47N-5	47.0	±5%	8	9	22	1300	2.0	200
MLH0402-56N-5	56.0	±5%	8	10	21	1250	2.0	200
MLH0603-1N0-03	1.0	±0.3	10	12	50	6000	0.10	500
MLH0603-1N2-03	1.2	±0.3	10	13	65	6000	0.10	500
MLH0603-1N5-03	1.5	±0.3	10	13	47	6000	0.10	500
MLH0603-1N8-03	1.8	±0.3	10	13	51	6000	0.10	500
MLH0603-2N2-03	2.2	±0.3	11	13	46	6000	0.10	500
MLH0603-2N7-03	2.7	±0.3	11	13	45	6000	0.10	500
MLH0603-3N3-03	3.3	±0.3	11	13	51	5900	0.12	500
MLH0603-3N9-03	3.9	±0.3	11	13	52	5600	0.14	500
MLH0603-4N7-03	4.7	±0.3	11	13	41	4800	0.16	500
MLH0603-5N6-5	5.6	±0.3	11	13	41	4350	0.18	500
MLH0603-6N8-5	6.8	±5%	11	13	44	3750	0.22	500
MLH0603-8N2-5	8.2	±5%	11	13	44	3300	0.24	500
MLH0603-10N-5	10.0	±5%	11	13	45	2850	0.26	400
MLH0603-12N-5	12.0	±5%	13	15	46	2500	0.28	400
MLH0603-15N-5	15.0	±5%	13	15	48	2150	0.32	400
MLH0603-18N-5	18.0	±5%	13	15	48	2100	0.35	400
MLH0603-22N-5	22.0	±5%	15	17	45	1850	0.40	400
MLH0603-27N-5	27.0	±5%	15	17	43	1680	0.45	400
MLH0603-33N-5	33.0	±5%	15	18	39	1580	0.55	400
MLH0603-39N-5	39.0	±5%	15	18	37 ⁽¹⁾	1400	0.60	300
MLH0603-47N-5	47.0	±5%	15	18	35 ⁽¹⁾	1200	0.70	300
MLH0603-56N-5	56.0	±5%	15	18	32 ⁽¹⁾	1100	0.75	300
MLH0603-68N-5	68.0	±5%	15	18	34 ⁽¹⁾	1050	0.85	300
MLH0603-82N-5	82.0	±5%	15	18	32 ⁽¹⁾	900	1.0	300
MLH0603-R10-5	100	±5%	15	18	20 ⁽¹⁾	850	1.2	300

Type Number	L (nH) 100 MHz	L tol.	Q min 100 MHz	Q typ 100 MHz	Q typ 800 MHz	SRF min (MHz)	R _{DC} max (Ω)	I max (mA)
MLH0603-R12-5	120	±5%	8 ⁽³⁾	16 ⁽³⁾	23 ⁽²⁾	730	1.6	250
MLH0603-R15-5	150	±5%	8 ⁽³⁾	14 ⁽³⁾	23 ⁽²⁾	650	2.0	250
MLH0603-R18-5	180	±5%	8 ⁽³⁾	14 ⁽³⁾	21 ⁽²⁾	570	2.4	250
MLH0603-R22-5	220	±5%	8 ⁽³⁾	13 ⁽³⁾	20 ⁽²⁾	530	2.8	200
MLH0805-1N5-03	1.5	±0.3	11	13	40	6000	0.10	500
MLH0805-1N8-03	1.8	±0.3	11	13	45	6000	0.10	500
MLH0805-2N2-03	2.2	±0.3	11	13	48	6000	0.10	500
MLH0805-2N7-03	2.7	±0.3	11	13	40	6000	0.10	500
MLH0805-3N3-03	3.3	±0.3	13	15	56	6000	0.13	500
MLH0805-3N9-03	3.9	±0.3	13	15	54	5400	0.15	500
MLH0805-4N7-03	4.7	±0.3	13	15	50	4500	0.20	500
MLH0805-5N6-03	5.6	±0.3	13	15	53	4000	0.23	500
MLH0805-6N8-5	6.8	±5%	13	15	51	3650	0.25	500
MLH0805-8N2-5	8.2	±5%	13	15	53	3000	0.28	500
MLH0805-10N-5	10.0	±5%	14	16	45	2500	0.30	500
MLH0805-12N-5	12.0	±5%	14	16	48	2450	0.35	400
MLH0805-15N-5	15.0	±5%	15	17	48	2000	0.40	400
MLH0805-18N-5	18.0	±5%	15	17	43	1750	0.45	400
MLH0805-22N-5	22.0	±5%	15	17	47	1700	0.50	400
MLH0805-27N-5	27.0	±5%	16	18	38	1550	0.55	400
MLH0805-33N-5	33.0	±5%	17	19	35	1350	0.60	400
MLH0805-39N-5	39.0	±5%	19	21	40	1300	0.65	400
MLH0805-47N-5	47.0	±5%	19	21	38	1200	0.70	400
MLH0805-56N-5	56.0	±5%	16	21	31	1150	0.75	400
MLH0805-68N-5	68.0	±5%	19	21	28	1000	0.80	400
MLH0805-82N-5	82.0	±5%	20	22	16	850	0.90	400
MLH0805-R10-5	100	±5%	21	23	-	730	1.0	400
MLH0805-R12-5	120 ⁽¹⁾	±5%	13 ⁽¹⁾	22	-	650	1.2	300
MLH0805-R15-5	150 ⁽¹⁾	±5%	13 ⁽¹⁾	22	-	550	1.4	300
MLH0805-R18-5	180 ⁽¹⁾	±5%	13 ⁽¹⁾	23	-	500	1.6	300
MLH0805-R22-5	220 ⁽¹⁾	±5%	12 ⁽¹⁾	20	-	450	1.8	300
MLH0805-R27-5	270 ⁽¹⁾	±5%	12 ⁽¹⁾	20	-	400	2.0	300
MLH0805-R33-5	330 ⁽¹⁾	±5%	12 ⁽¹⁾	22	-	380	3.0	300
MLH0805-R39-5	390 ⁽¹⁾	±5%	10 ⁽¹⁾	17	-	330	3.5	300
MLH0805-R47-5	470 ⁽¹⁾	±5%	10 ⁽¹⁾	17	-	300	4.0	300

(1) at 500 MHz

(2) at 300 MHz

(3) at 50 MHz

Inductance characteristics

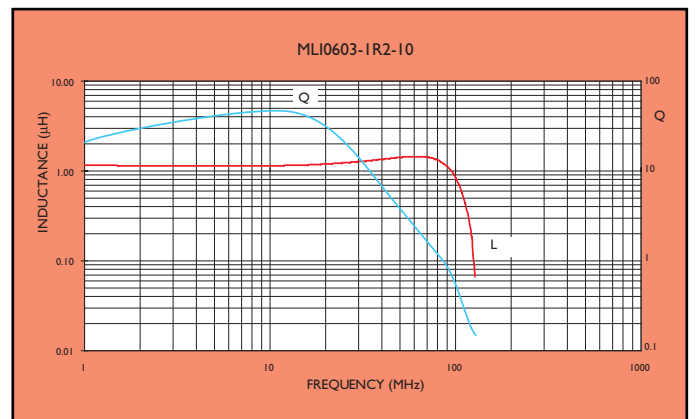
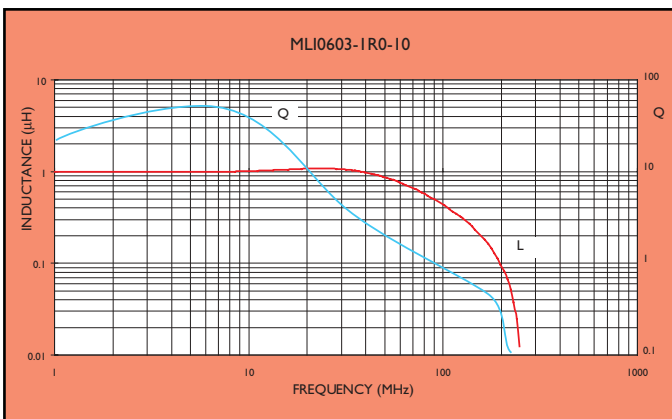
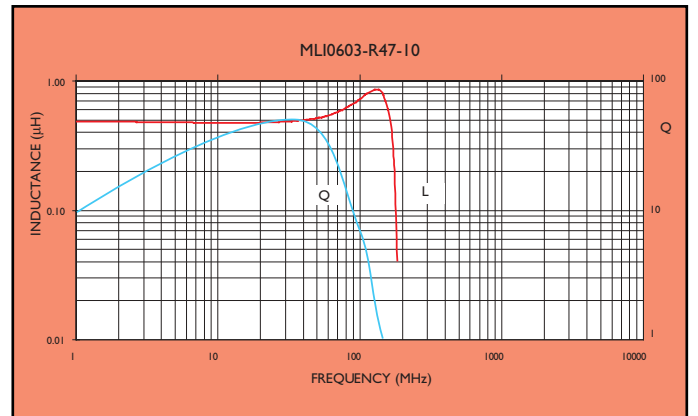
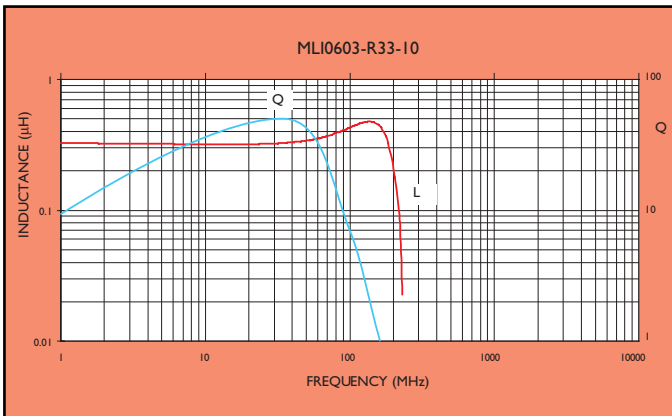
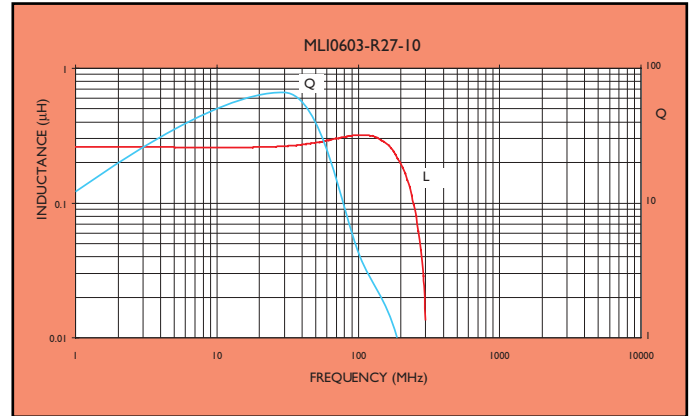
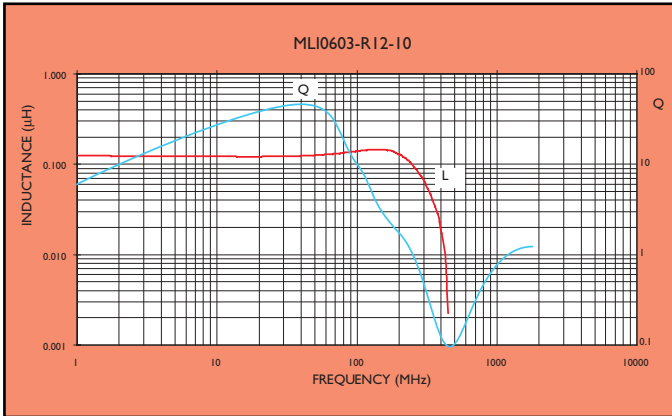
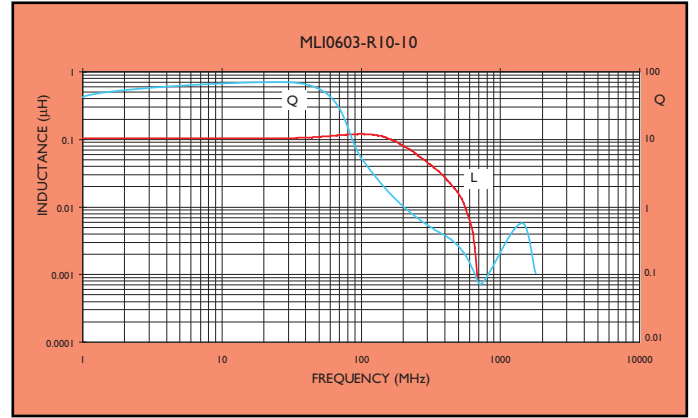
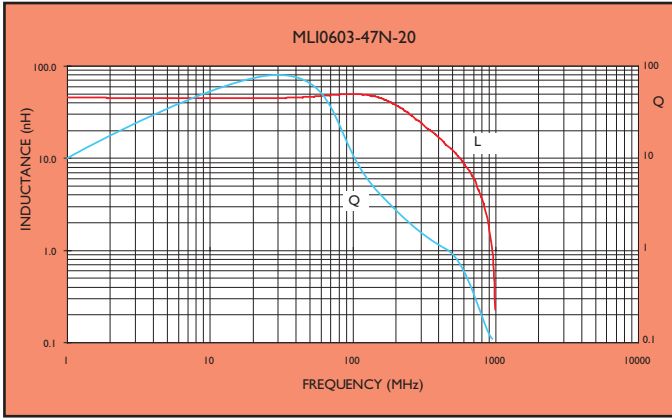

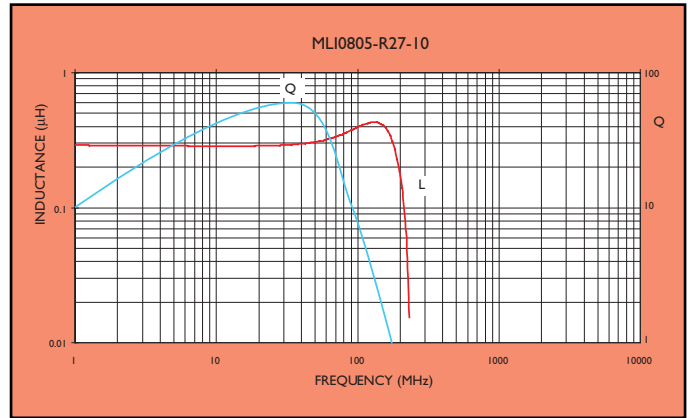
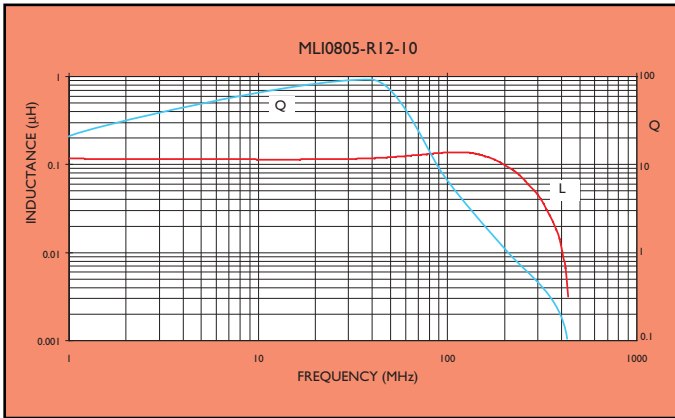
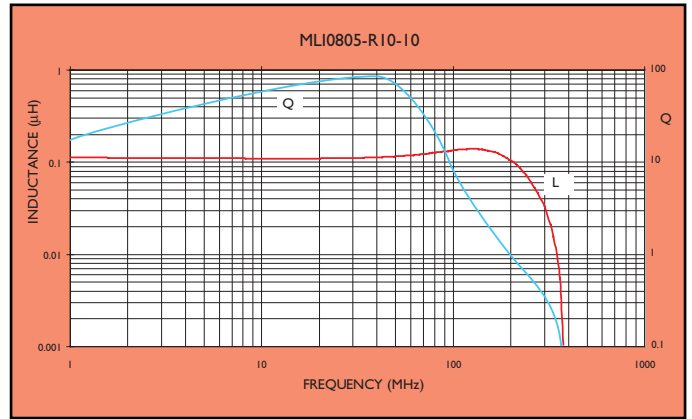
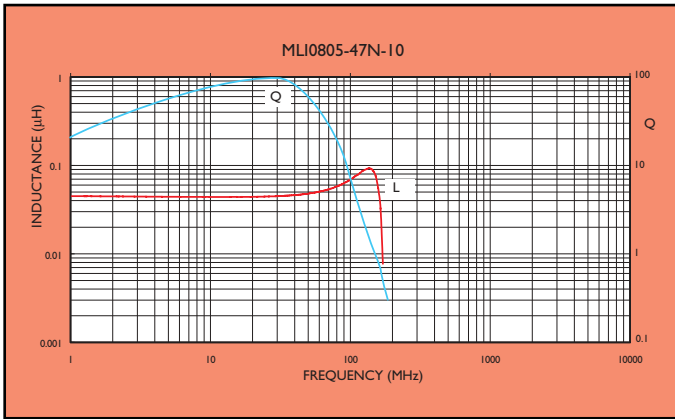
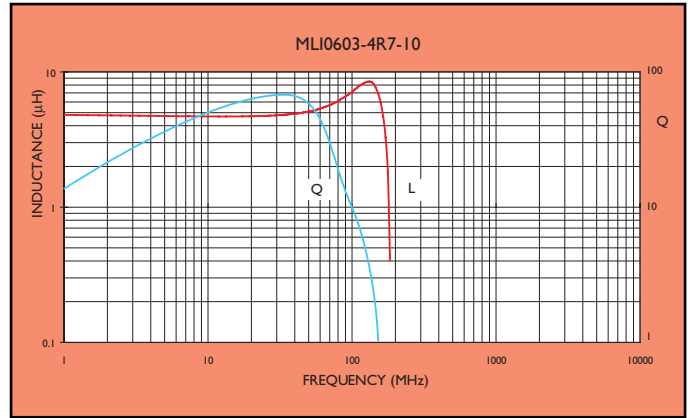
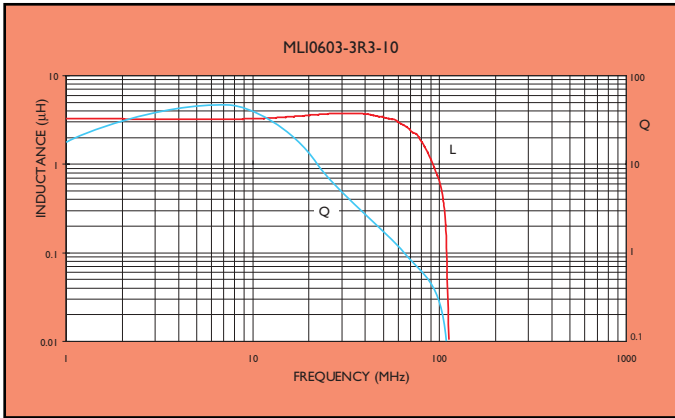
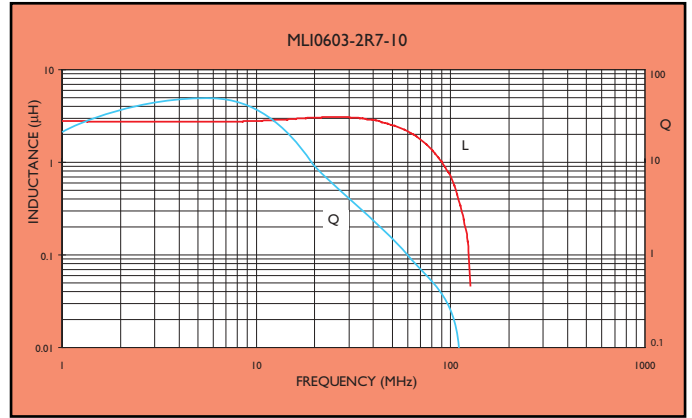
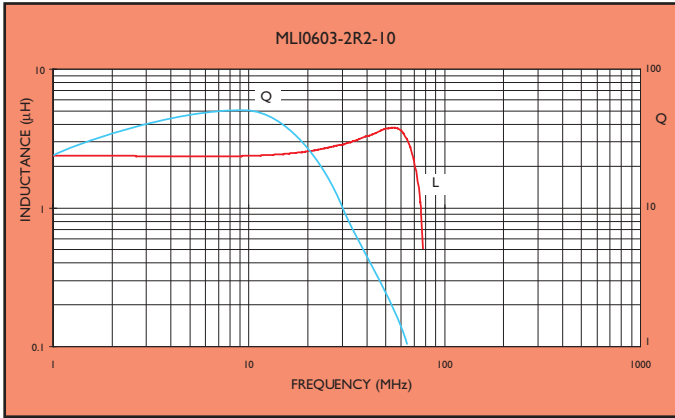

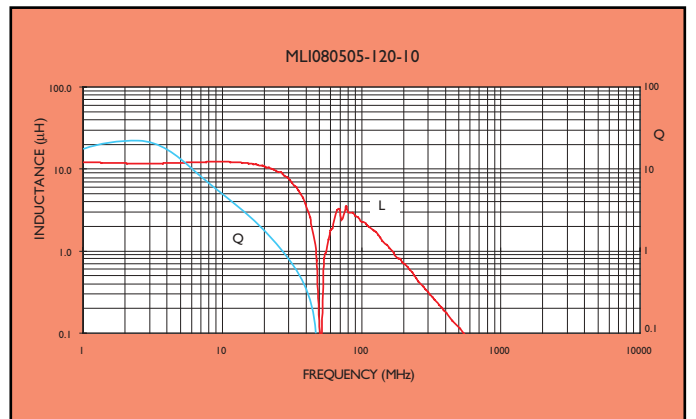
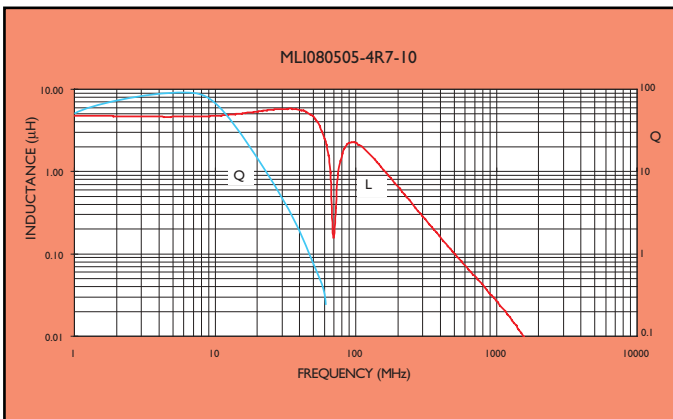
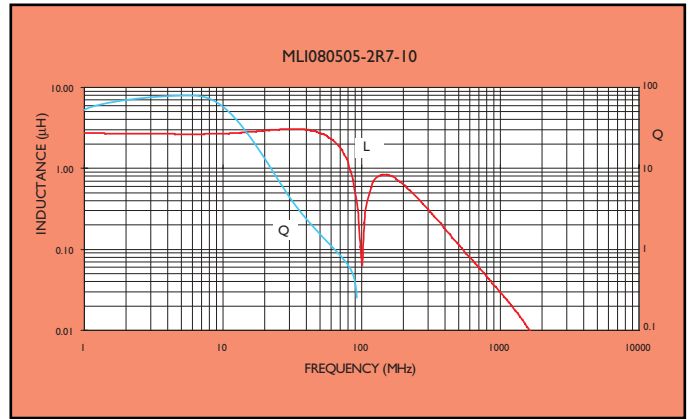
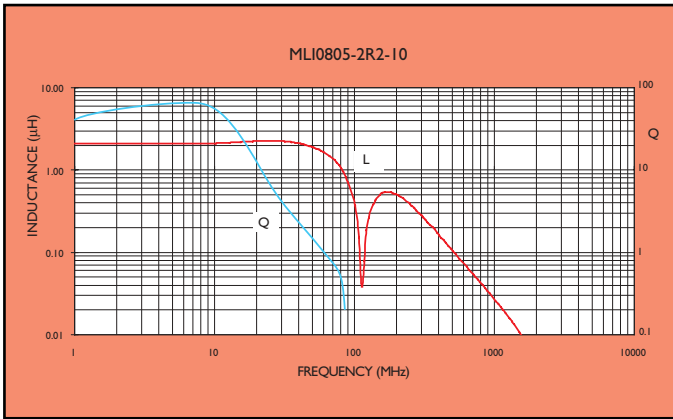
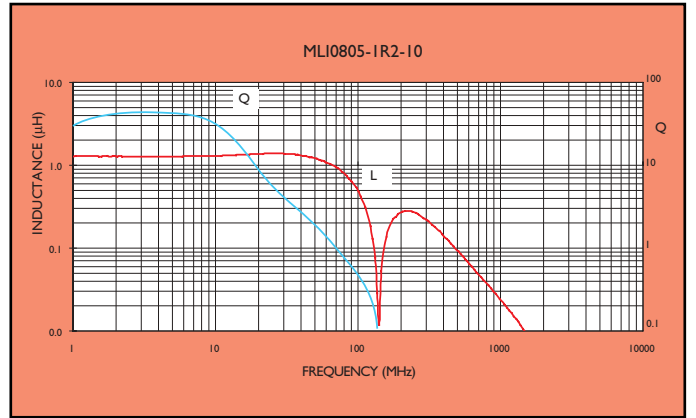
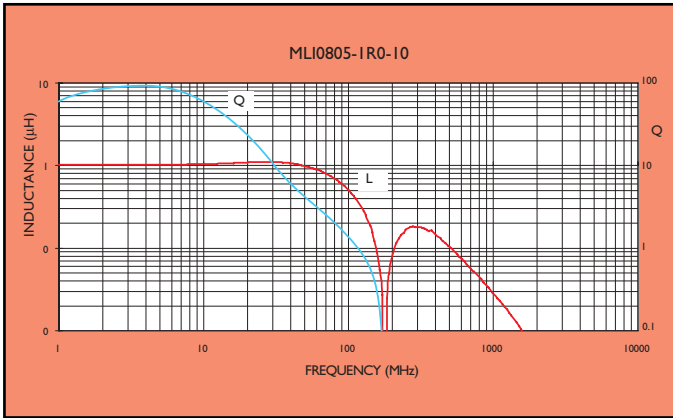
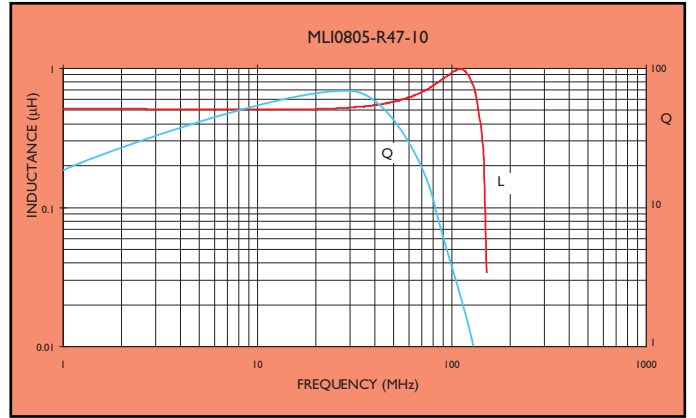
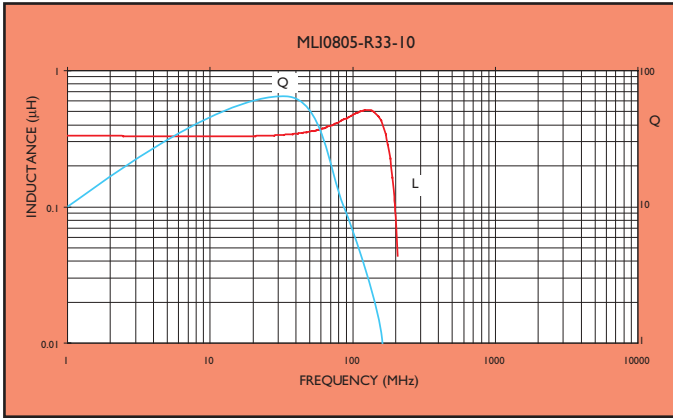

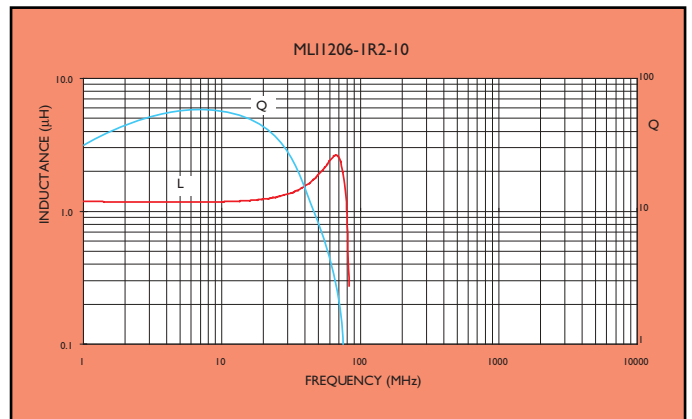
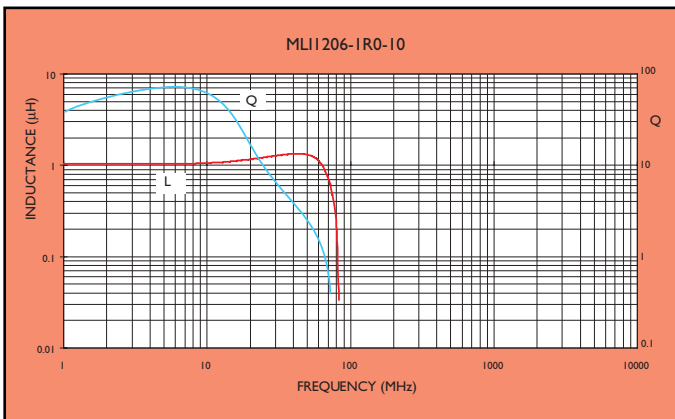
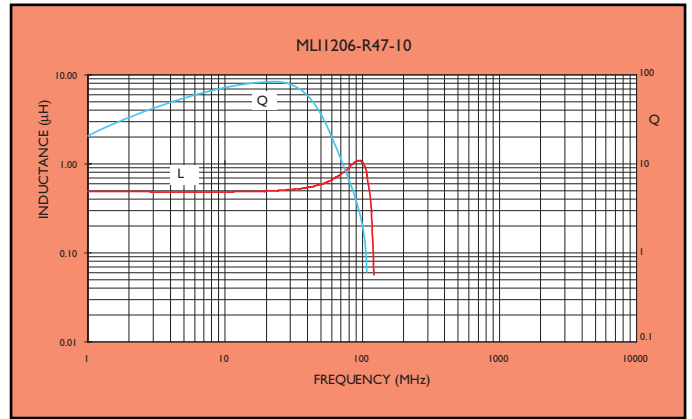
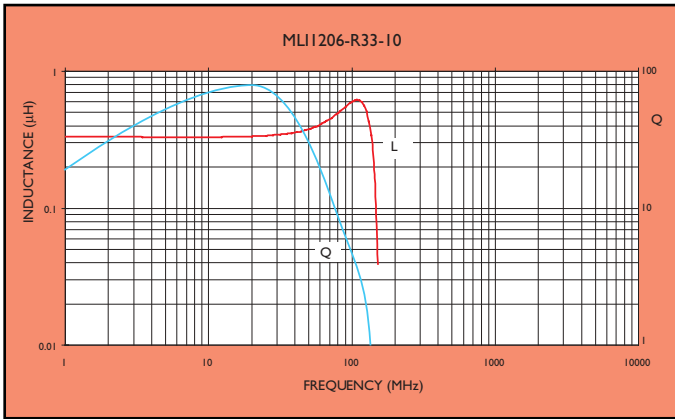
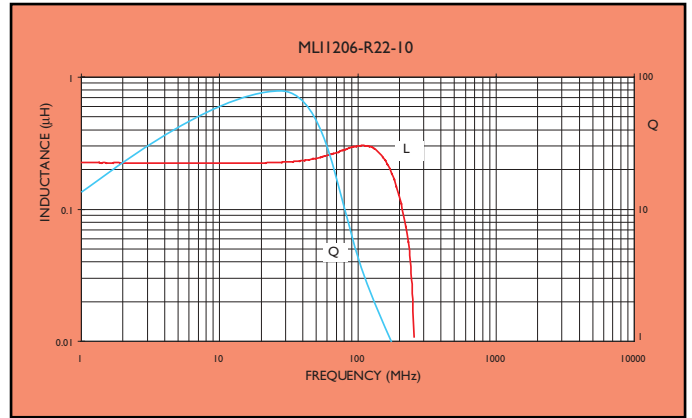
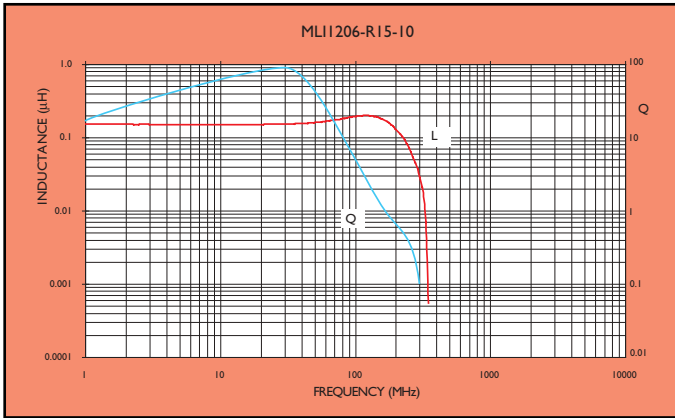
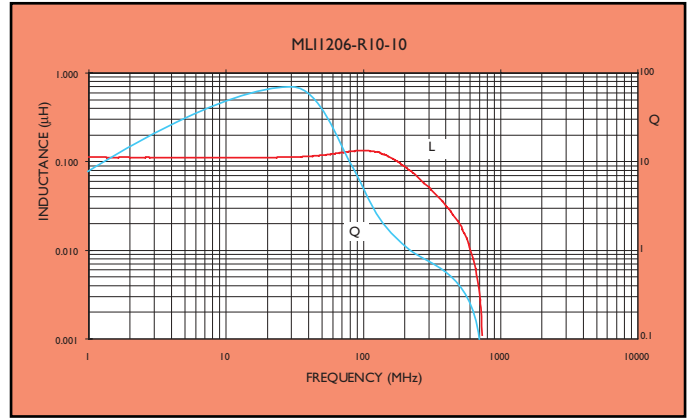
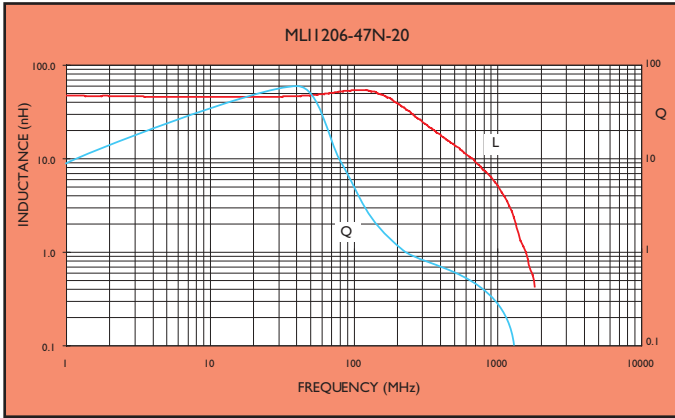

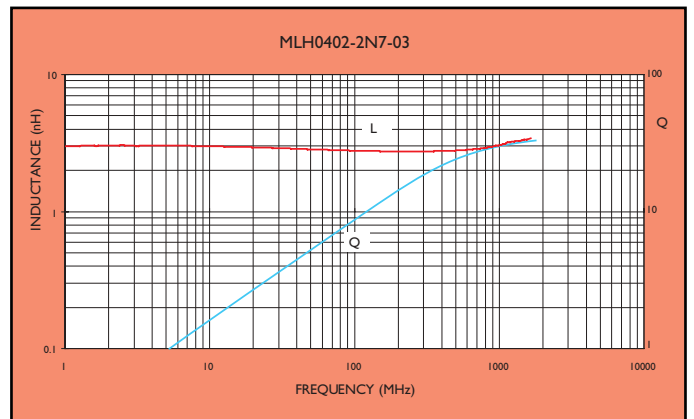
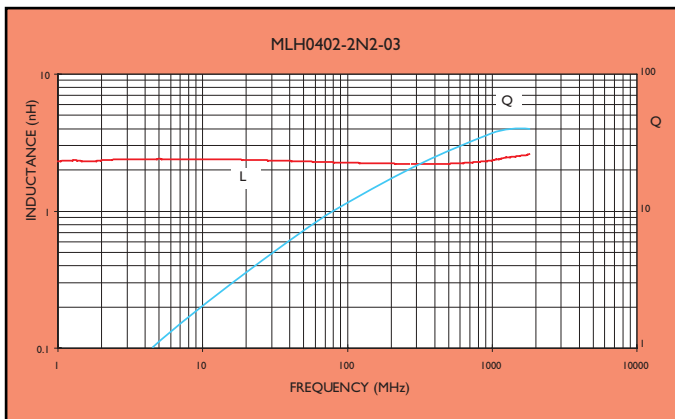
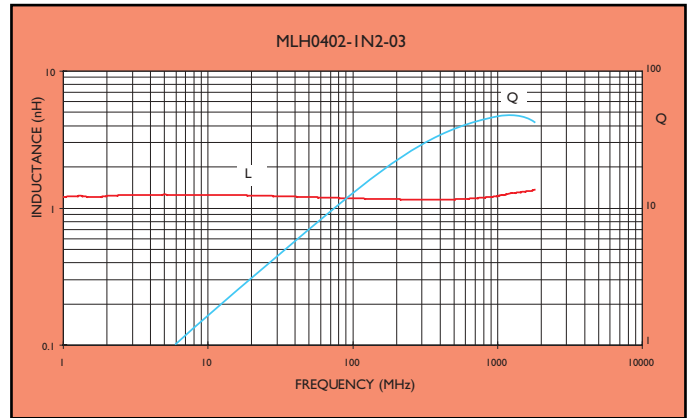
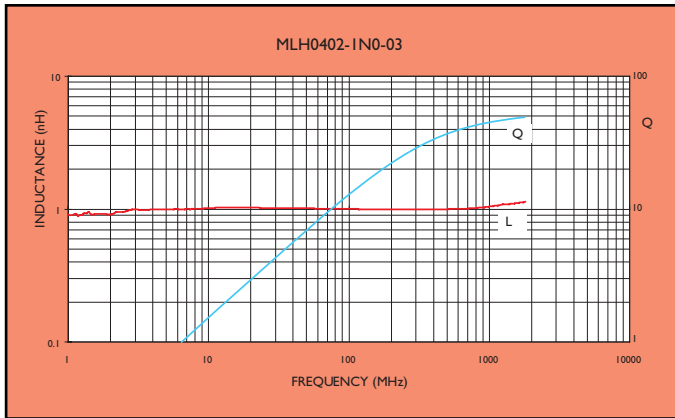
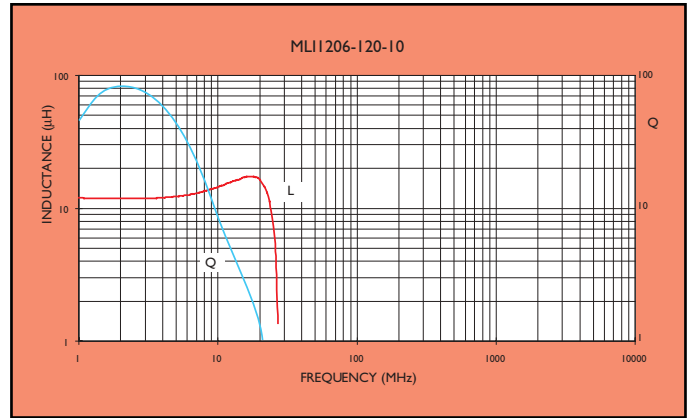
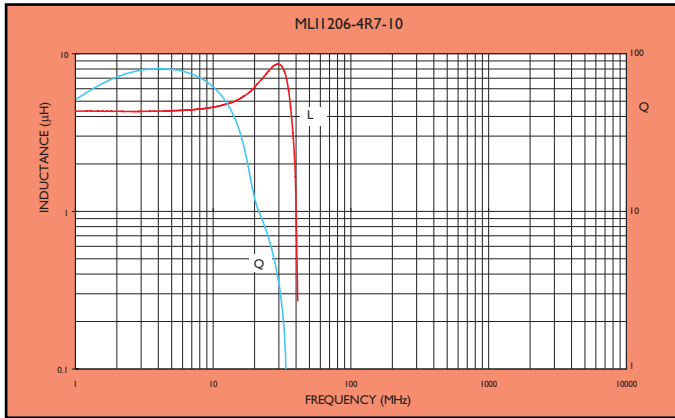
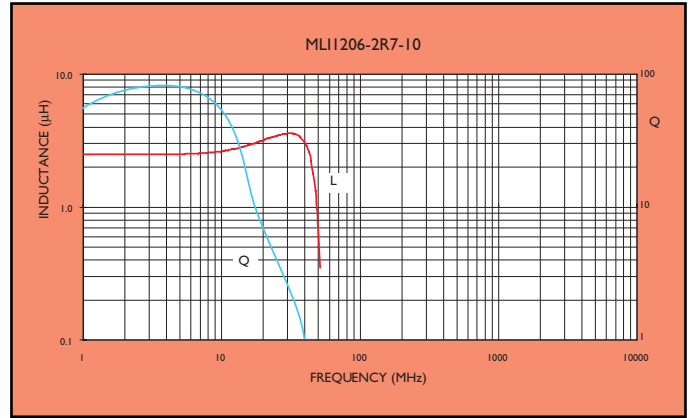
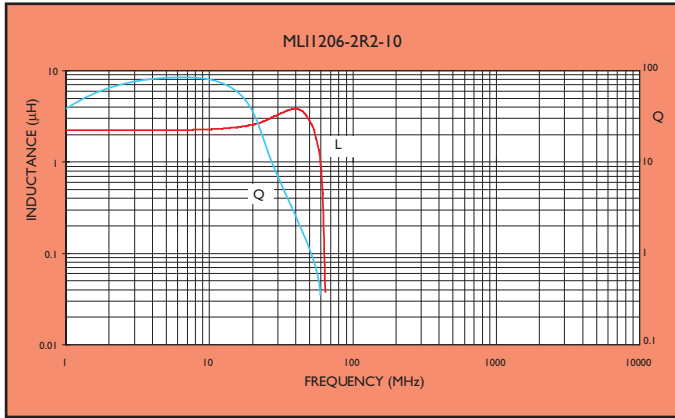

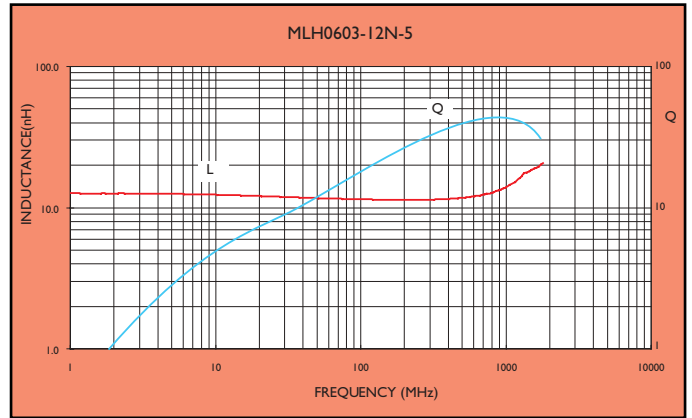
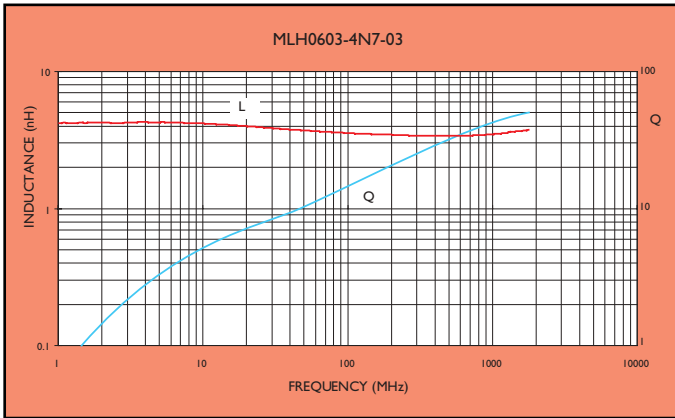
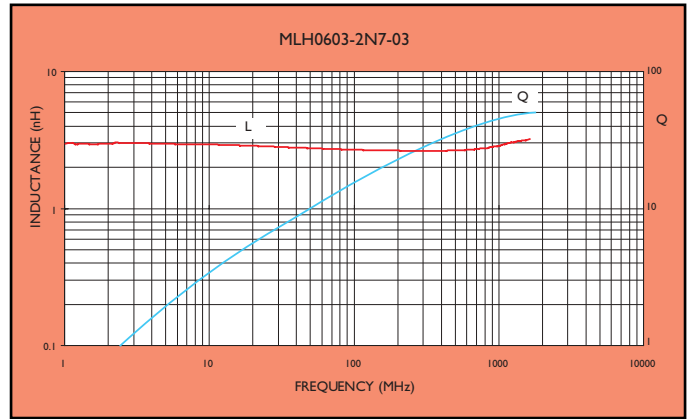
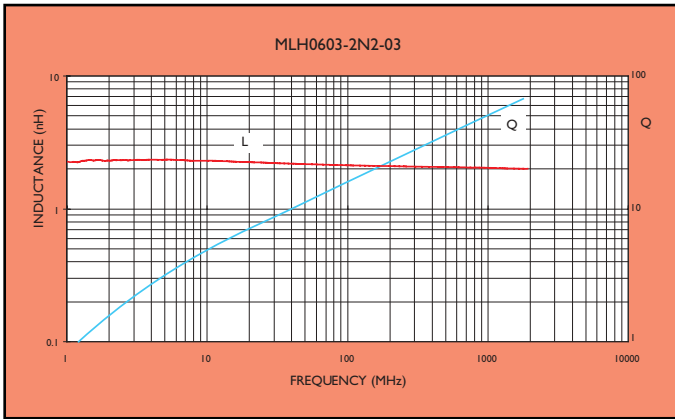
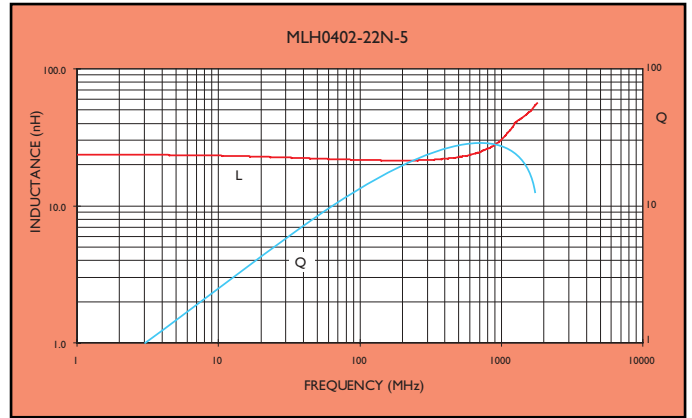
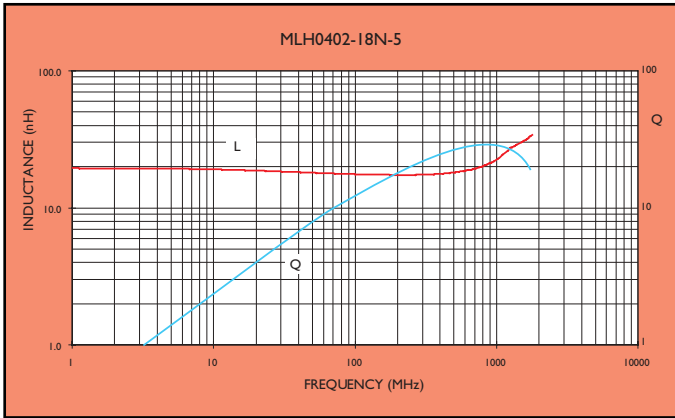
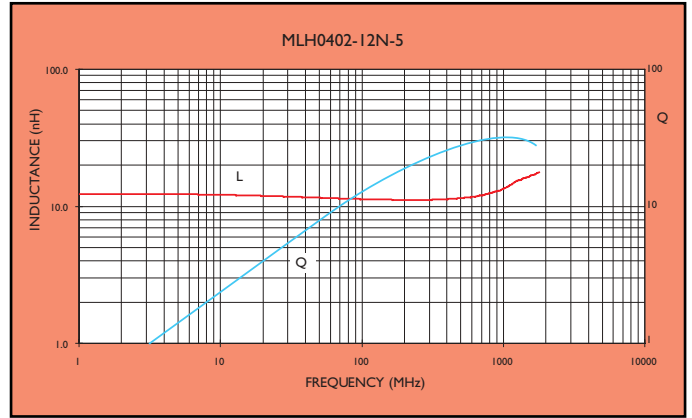
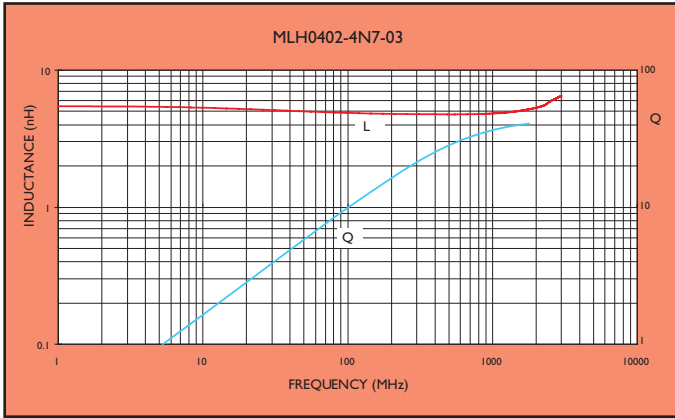

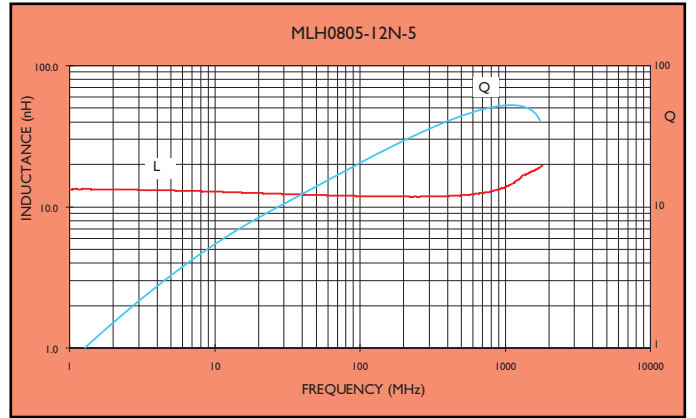
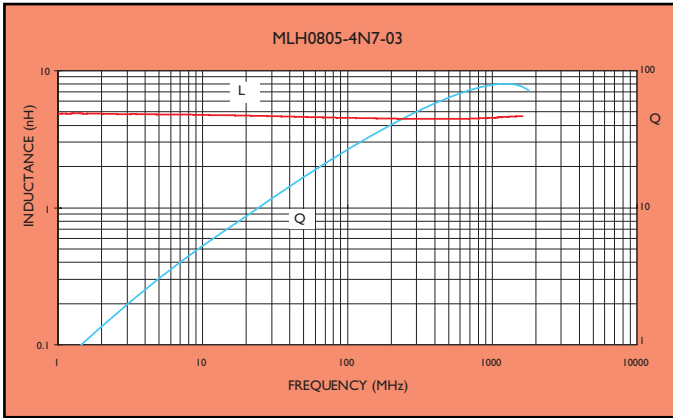
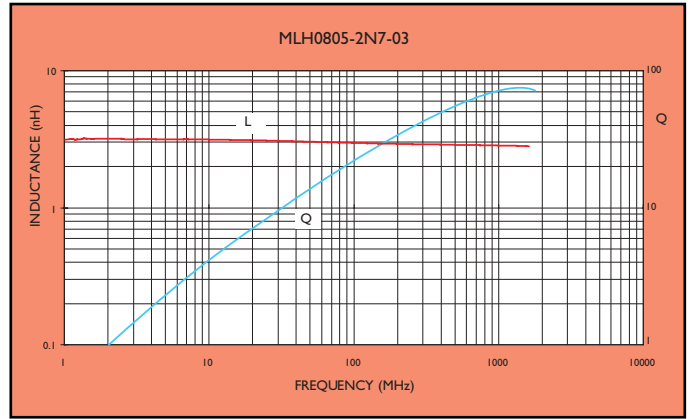
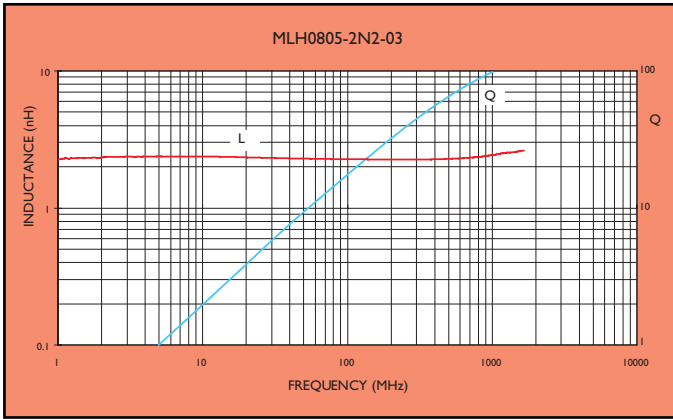
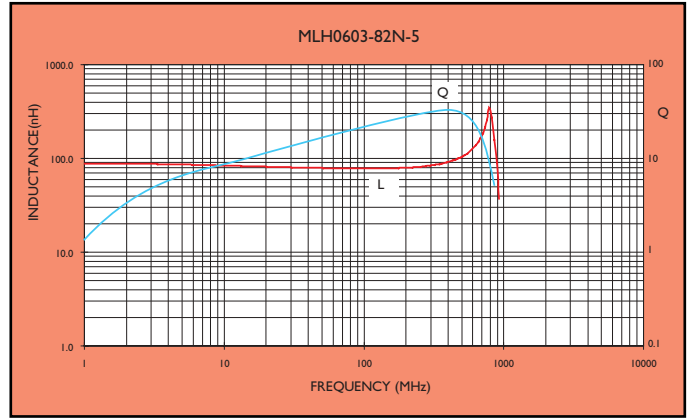
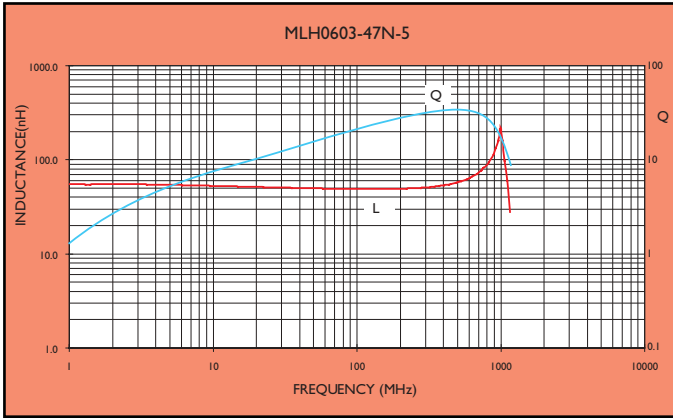
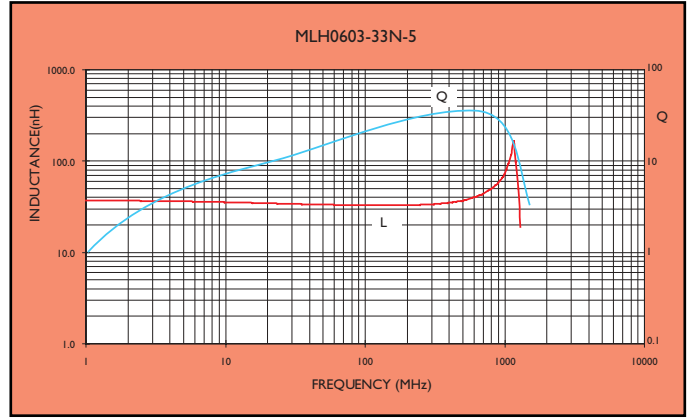
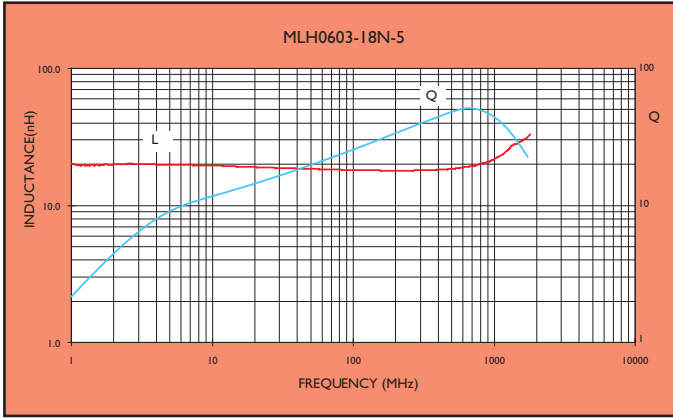

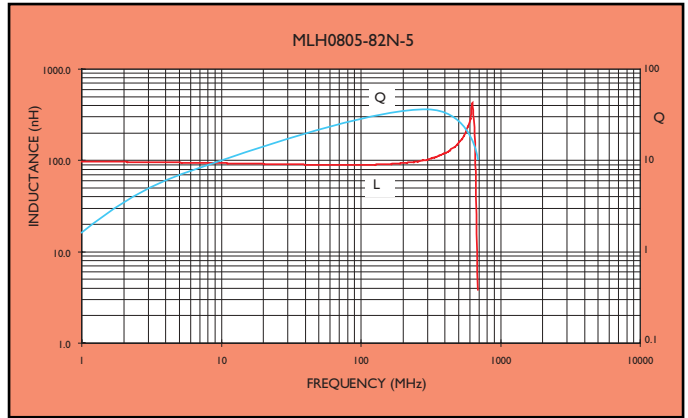
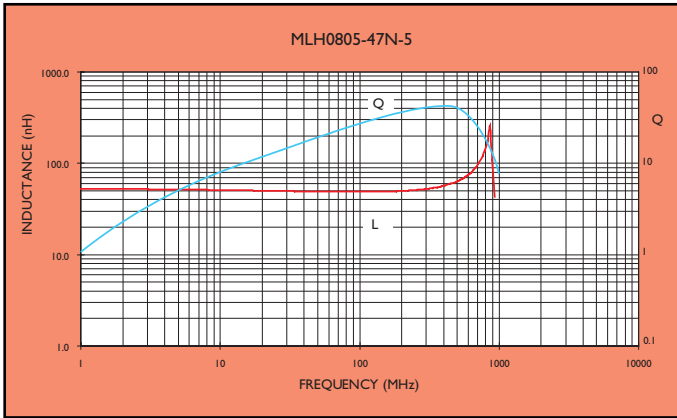
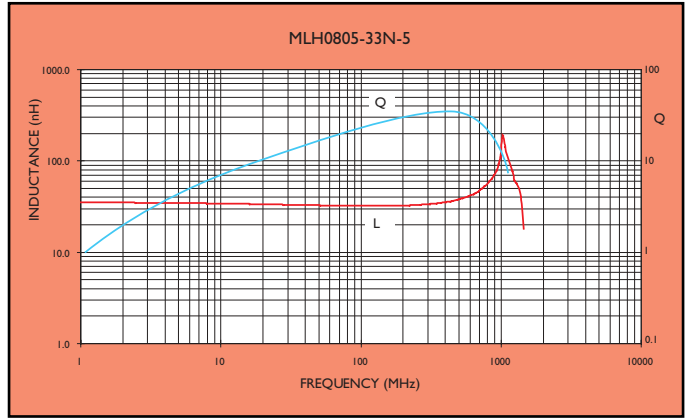
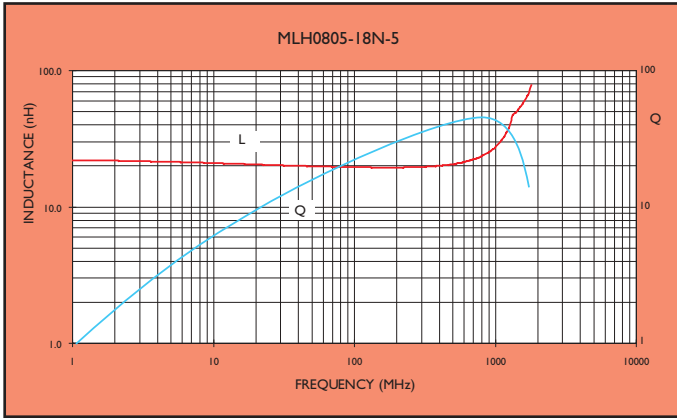

Reliability and Quality Controls

FERROXCUBE multilayer inductors are submitted to extensive tests to ensure high quality, high reliability and complete customer satisfaction. A brief description is given below.

Electrical test

The inductive components are tested 100% for inductance by automatic sorting machines. Samples from each lot of products are double-checked by QA personnel. All components shall have electrical properties within the tolerances specified in the product specification.

External visual inspection

Samples are inspected under 10 to 30 x magnification by microscope for any physical defect, such as chips, cracking, delamination, over-plating, etc.. No damage shall be found in the products.

Bending strength

The chips are soldered on the substrate (95x23x1.5mm. substrate dimension) and subjected to one bend of 2 mm. The duration is 30 seconds. No physical and mechanical damage shall be observed, L shall not have changed by more than 10% from the initial values, Q shall not have changed by more than 30% from the initial values and R_{DC} shall not have changed by more than 20% from the initial values.

Temperature shock test

The components are subjected to 100 temperature cycles.(step 1 → 30min, $-55^{\circ}\text{C} \pm 3$; step 2 → 3min, $25^{\circ}\text{C} \pm 2$; step 3 → 30 min, 125 ± 2 ; step 4 → 3 min, 25 ± 2). Measured after exposure in the room condition for 24hrs. No physical and mechanical damage shall be observed, the inductance shall not have changed by more than 10% from the initial value, Q shall not have changed by more than 30% from the initial value and R_{DC} shall not have changed by more than 20% from the initial value.

Loaded humidity test

The components are placed in a testing chamber at $40^{\circ}\text{C} \pm 2$ and 90-95% relative humidity for 1000 hrs. Measured after exposure in the room condition for 24hrs. No physical and mechanical damage shall be observed, L shall not have changed by more than 10% from the initial value, Q shall not have changed by more than 30% from the initial value and R_{DC} shall not have changed by more than 20% from the initial value.

Life test

Samples are tested at 125°C with rated current for 1000 hours, and 20% relative humidity. Measured after exposure in the room condition for 24hrs. After the test, no physical and mechanical damage shall be observed. L shall not have changed by more than 10% from the initial value, Q shall not have changed by more than 30% from the initial value and R_{DC} shall not have changed by more than 20% from the initial value.

Cold resistance

Samples are tested at -55°C for 1000 hours. Measured after exposure in the room condition for 24hrs. After the test, no physical and mechanical damage shall be observed. L shall not have changed by more than 10% from the initial value, Q shall not have changed by more than 30% from the initial value and R_{DC} shall not have changed by more than 20% from the initial value.

Soldering

The advantages of good solderability of both components and substrate can be summarized as follows:

1. Lower soldering temperatures and shorter dwell times prevent damage to devices or dissolution of metallization. The thickness of inter-metallic zones is minimized, thus increasing mechanical integrity and providing a stable electrical connection.

2. It permits the use of a less active flux. Therefore the flux residue activity is low and cleaning the substrate may be unnecessary.

3. Better cost effectiveness by shorter production times owing to less re-working and repairs.

FERROXCUBE multilayer chip beads and inductors have a nickel barrier and solder coated termination, which offers excellent solderability and solder leach resistance.

The products are suitable for both reflow and wave soldering.

The use of silver for electrodes and terminations in multilayers ensures high electrical conductivity, which minimises heat generation and cross talk.

The terminal electrode forms a conductive connection to the circuit. It is formed by three layers.

- Silver: for a good conductivity
- Nickel: protects silver termination against leaching
- Tin-lead: applied to insure good solderability

Recommended solder lands

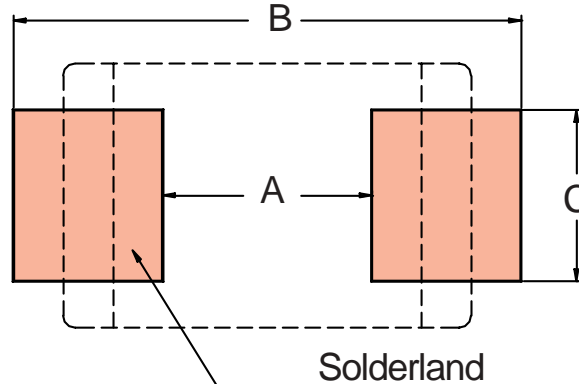

MLS-MLP-MLN

Size	A	B	C
0402	0.4	1.2 ~ 1.4	0.4
0603	0.8	2.4 ~ 3.4	0.6
0805	1.2	3.0 ~ 4.0	1.0
1206	2.0	4.2 ~ 5.2	1.2
1210	2.0	5.5 ~ 6.5	1.8
1806	3.0	5.5 ~ 6.5	1.2
1812	3.0	5.5 ~ 6.5	2.4

MLI

Size	A	B	C
0603	0.8	2.4 ~ 3.4	0.6
0805	1.2	3.0 ~ 4.0	1.0
080505	1.2	3.0 ~ 4.0	1.0
1206	2.0	4.2 ~ 5.2	1.2

MLH

Size	A	B	C
0402	0.4	1.2 ~ 1.4	0.4
0603	0.8	2.4 ~ 3.4	0.6
0805	1.2	3.0 ~ 4.0	1.0

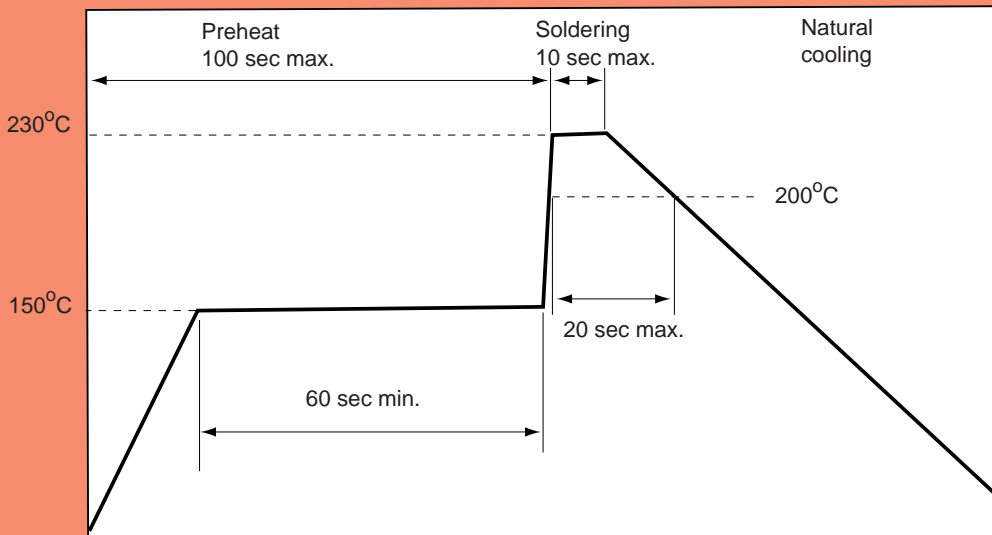

Recommended temperature profile for reflow soldering.

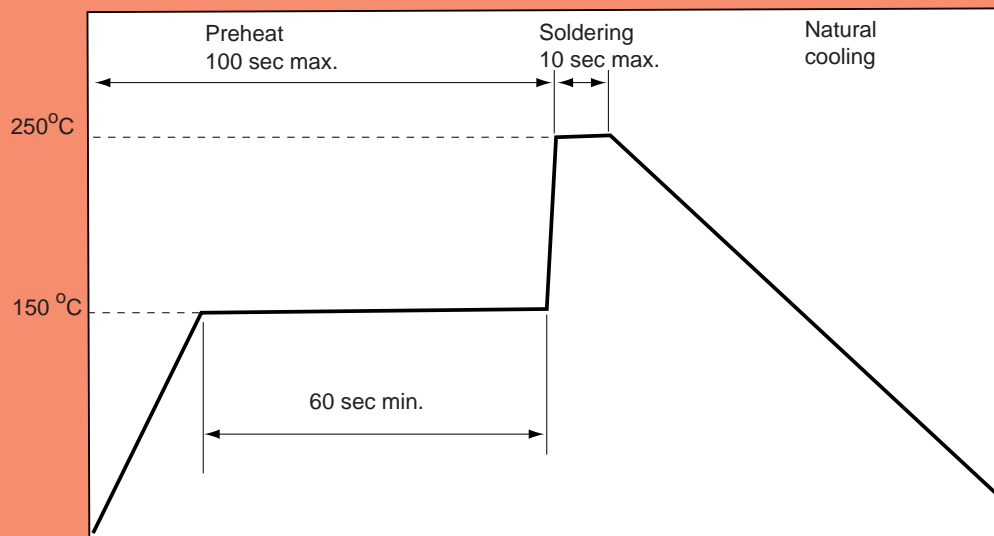

Recommended temperature profile for wave soldering.

Packing

FERROXCUBE multilayer products are delivered taped and reeled, ready for use in automatic pick-and-place equipment, according to IEC 286-A and EIA 481-A.

Reels are sealed in plastic bags with desiccant.

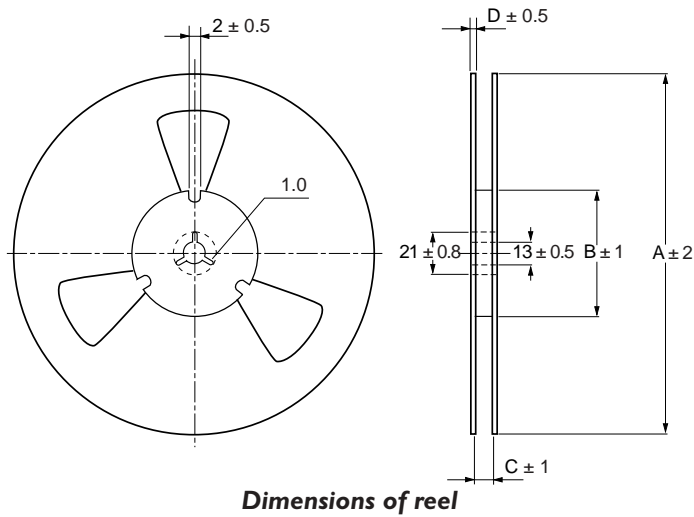

Packing quantities

Size	PCS / REEL
0402	10.000
0603	4.000
0805	4.000
080505	3.000
1206	3.000
1210	2.500
1806	2.000
1812	1.000

MLS-MLP-MLN Dimensions in mm

Size	A	B	C	D
0402	178	60	10	2
0603	178	60	10	2
0805	178	60	10	2
1206	178	60	10	2
1210	178	60	10	2
1806	178	60	14	2
1812	178	60	14	2

MLI

Size	A	B	C	D
0603	178	60	10	2
0805	178	60	10	2
080505	178	60	10	2
1206	178	60	10	2

MLH

Size	A	B	C	D
0402	178	60	12	1.5
0603	178	60	12	1.5
0805	178	60	12	1.5

Dimensions of blister tape

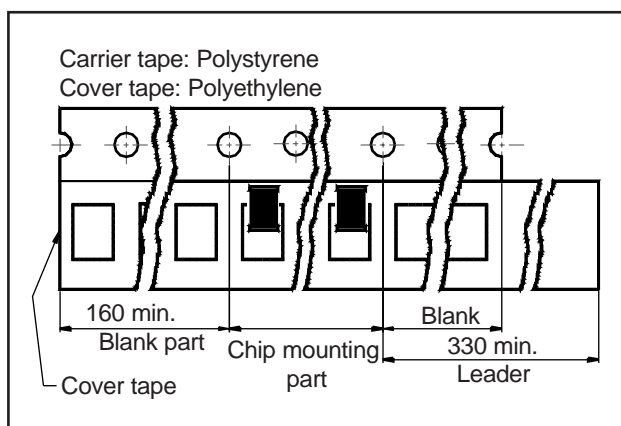
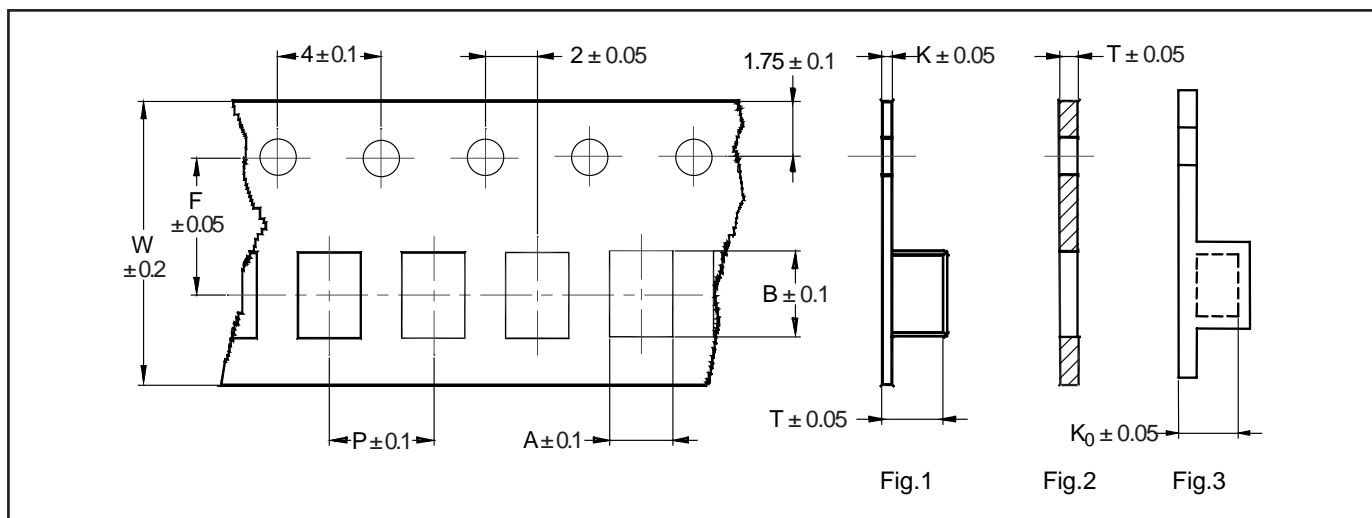

Material

- Blister tape : Paper for sizes 0402 and 0603.
Polystyrene for the rest.
- Cover film : Polyethylene

MLS-MLP-MLN

Dimensions in mm

Size	A	B	T	W	P	F	K	Tape Fig.
0402	0.65	1.15	0.7	8.0	2.0	3.5		2
0603	0.975	1.8	1.05	8.0	4.0	3.5		2
0805	1.54	2.32	1.15	8.0	4.0	3.5	0.2	1
1206	1.94	3.54	1.29	8.0	4.0	3.5	0.2	1
1210	2.80	3.42	1.64	8.0	4.0	3.5	0.2	1
1806	1.94	4.94	1.90	12	4.0	5.5	0.3	1
1812	3.64	4.94	1.80	12	8.0	5.5	0.3	1

MLI

Size	A	B	T	W	P	F	K	Tape Fig.
0603	1.1	1.9	0.95	8	4	3.5		2
0805	1.54	2.32	1.15	8	4	3.5	0.2	1
080505	1.54	2.32	1.35	8	4	3.5	0.2	1
1206	1.94	3.54	1.29	8	4	3.5	0.2	1

MLH

Size	A	B	K ₀	W	P	F	K	Tape Fig.
0402	0.65	1.15	0.6	8	2	3.5	0.6	3
0603	1.1	1.9	0.95	8	4	3.5	0.95	3
0805	1.42	2.25	⁽¹⁾	8	4	3.5	0.22	3

⁽¹⁾: L < 180nH K₀=1.04
 L ≥ 180nH K₀=1.4

Storage requirements

Storage requirements advised here should be observed in order to ensure the soldering of the exposed electrode:

- Maximum ambient temperature shall not exceed 40°C. Storage temperature higher than 40°C could result in deformation of packing materials.
- Maximum relative humidity recommended for storage is 70%. High humidity with high temperature can accelerate the oxidation of the tin-lead plating on the termination and reduce the solderability of the components.
- Sealed plastic bags with desiccant shall be used to reduce the oxidation of electrodes and shall only be opened prior to use. After unpacking, reseal or store with a desiccant.
- Products shall not be stored in environments with the presence of harmful gases containing sulfur or chlorine.

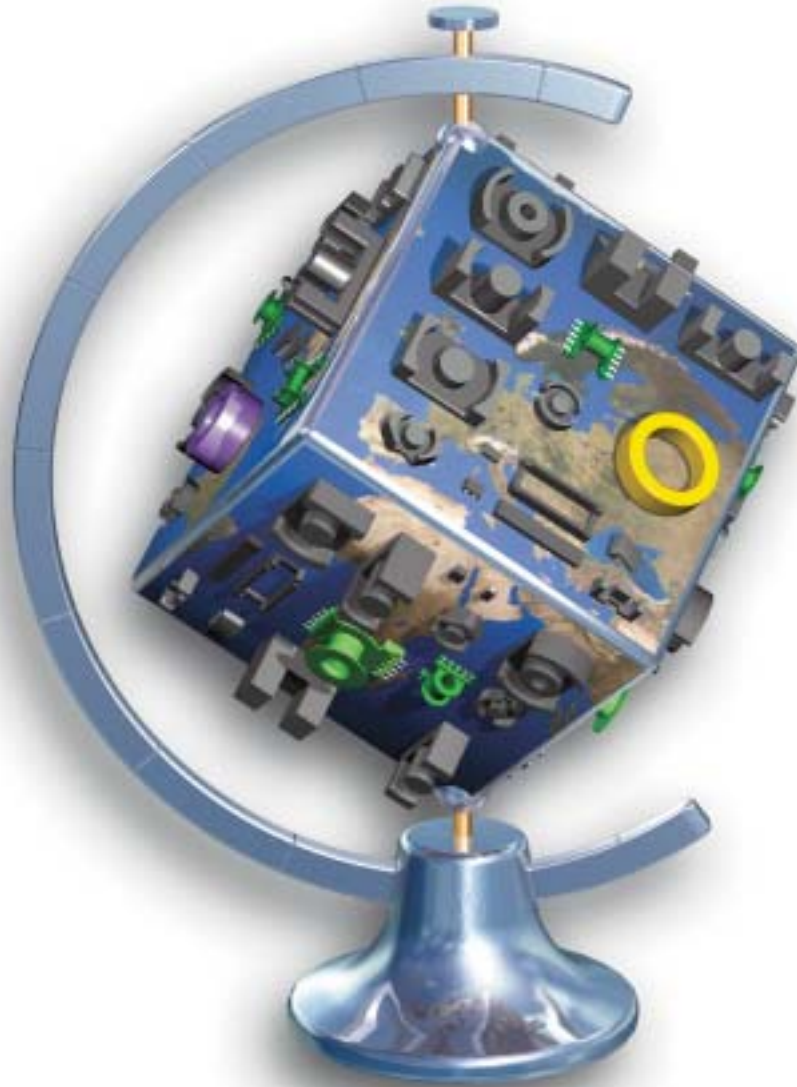

If you require impedance or inductance graphs which are not presented in this brochure,
please visit our web site at:

www.ferroxcube.com