

IIC

Integrated
Inductive
Components

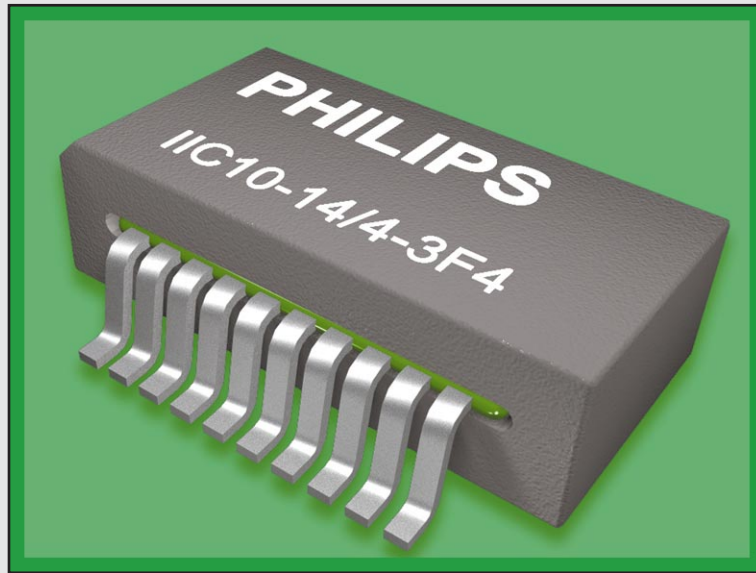

IIC

Integrated Inductive Components

Contents

Introduction	3
Features and Applications	4
Design example	8
Materials	9
Type Number structure	14
Environmental aspects	14
Product range	14
General product data	15
Product specifications	16
Reliability and Quality Control	20
Soldering and recommended solder lands	21
Packing	22
Storage requirements	23

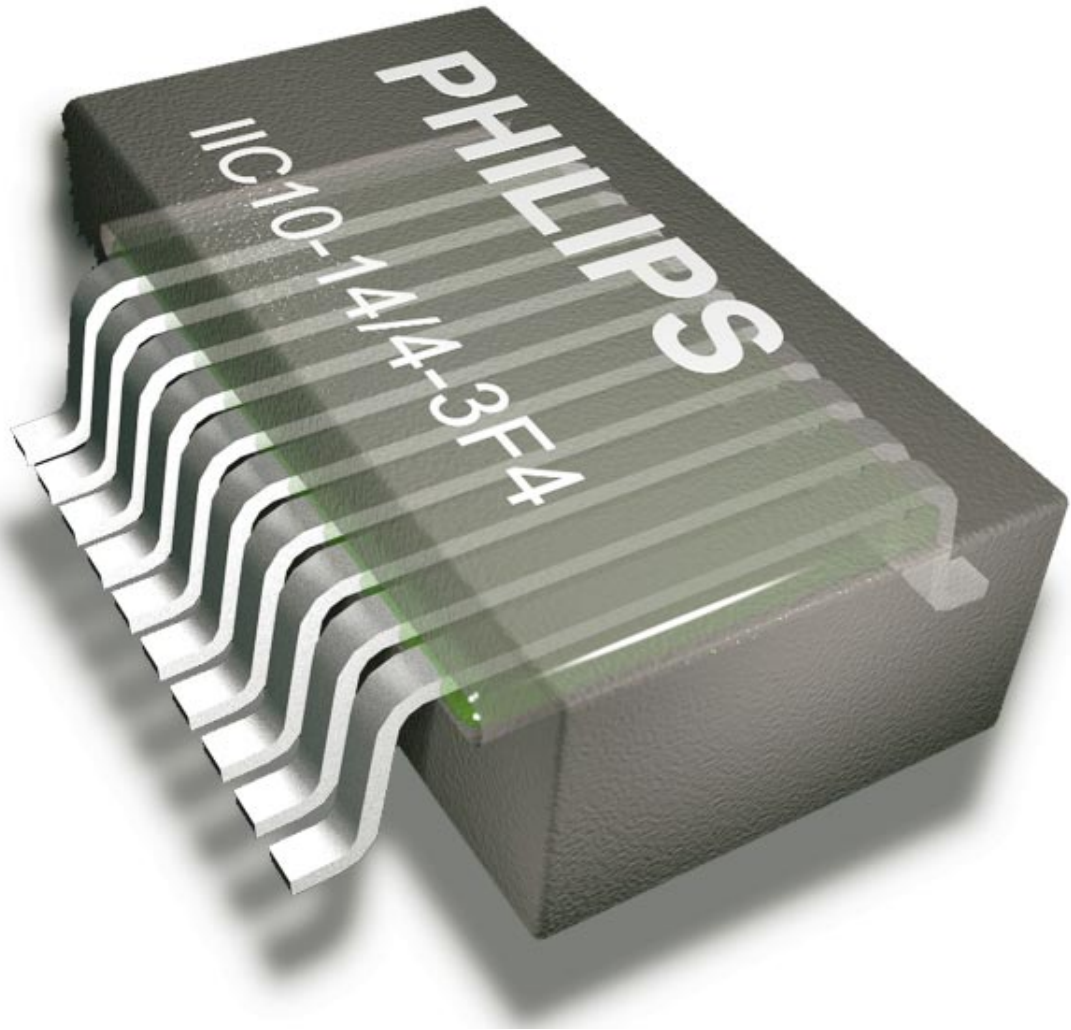

Fig.1 View inside an IIC10 model

Introduction

For the majority of today's designs it is desirable to have low profile inductive components. This allows designers not only to make low profile equipment, but also to place the inductive device anywhere on the PCB without adaptations to the housing. This is especially true when the inductive component matches the height of other components on the board, for instance IC's which are usually about 3mm high.

One way to achieve this objective is to simply lower existing core designs like E- or RM cores. When these cores get really flat it becomes difficult to accommodate the windings, especially if these must be able to carry large currents.

Windings can be flattened to adapt them to the shape of the component, as in planar magnetics. In the fully integrated planar device the possibility to use the copper layer on the PCB as a winding is exploited for the first time.

Another way to do this is demonstrated in the new Integrated Inductive Component (IIC), presented in this brochure. This product consists of a rectangular ferrite sleeve with an inserted copper lead frame. This sleeve is pressed in one piece although the slot is only 0.75 mm high, and it can also comprise a partial airgap. The lead frame is surrounded by a moulding of a high tech resin to keep the leads together and to insulate them from the ferrite core. After insertion the leads are bent in a so-called gull wing shape to form contact pads, just like with most standard SMD IC's. In fact, the finished product really looks like an IC from the outside. It closely resembles the SOT outline and can be handled by standard pick and place equipment as well as soldered together with other IC's on the board.

The leads in the moulding form one half of a winding which is completed by a track on the PCB. In this way, depending on the PCB layout, one or more inductors with up to 10 turns can be constructed. The same product can be applied to make 1 inductor with 10 turns or 2 with 5 turns etc.

The IIC design can perform several magnetic functions, depending on the material and the presence of a partial airgap.

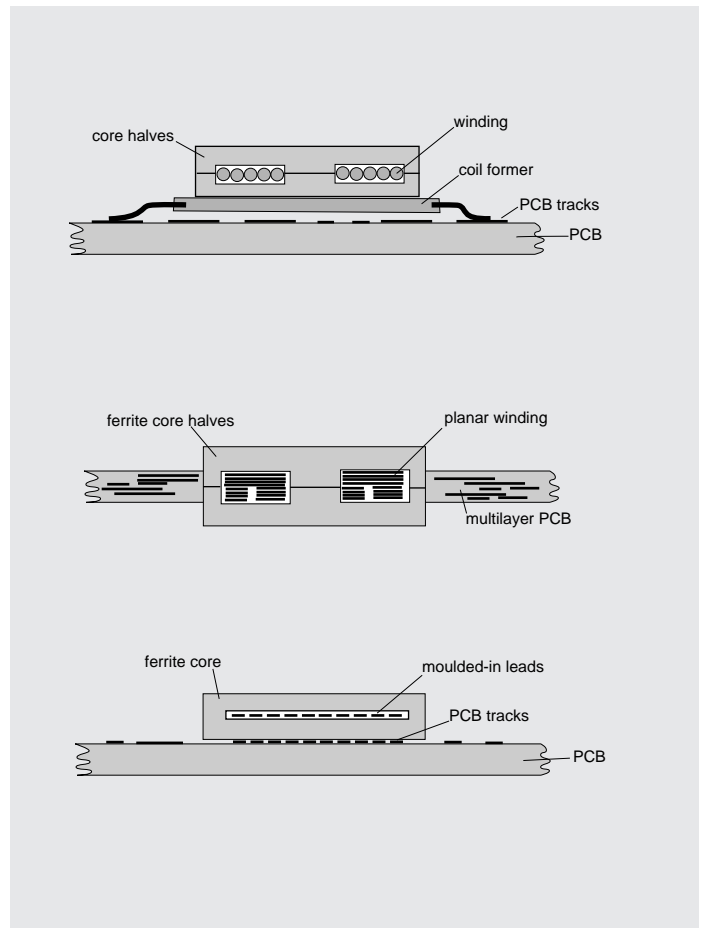

Fig.2 Three basic principles to make a low profile inductive component.

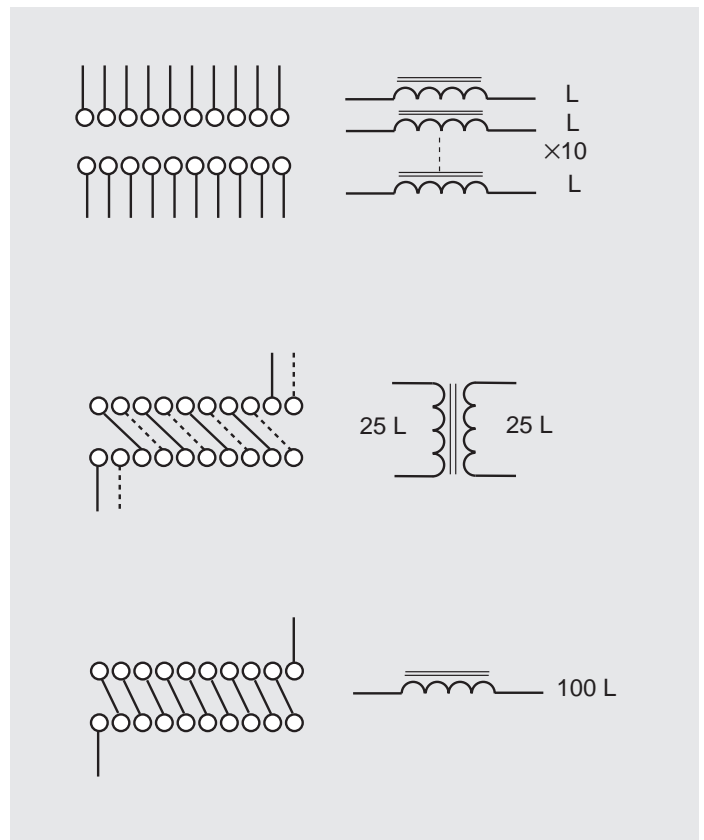

Fig.3 PCB track examples.

Features

- Inductive SMD component that looks like a standard IC outline (SOT).
- Windings are completed by PCB tracks.
- Automatic placement and soldering together with other IC's on the board.
- Suitable for reflow soldering.
- Wide range of magnetic functions can be realized with the same product, depending on track layout.
- Superior physical properties.
- Available in standard EIA and EIAJ tape-and-reel.
- Operating temperature -55°C to +150°C.

Applications

IIC with partial airgap

This product type has a partial airgap to improve energy storage capability. Its performance has all characteristics of a stepped choke. Possible magnetic functions are:

- power inductor
- output choke
- EMI-choke with bias

Power inductors are applied as output choke in switched mode power supplies, inductor in high frequencies DC/DC (buck/boost) converters or resonant inductors in resonant converters. Because of the limited number of turns the product will only be of interest for fairly high frequencies (≥ 200 kHz).

The curves of L as a function of DC bias exhibit the effect of a partial airgap. For comparison, curves for products with a complete airgap and without are shown in Fig.4. For all these applications saturation flux density should be as high as possible with low power losses. Therefore 3C30 is the ideal material here. However for very high frequencies (≥ 500 kHz) a better choice would be 3F4.

EMI-chokes often suffer from saturation when used without current compensation in line with elevated DC or AC bias currents. The design with a partial airgap avoids complete saturation to a large extend. The suppression effect remains at an acceptable level.

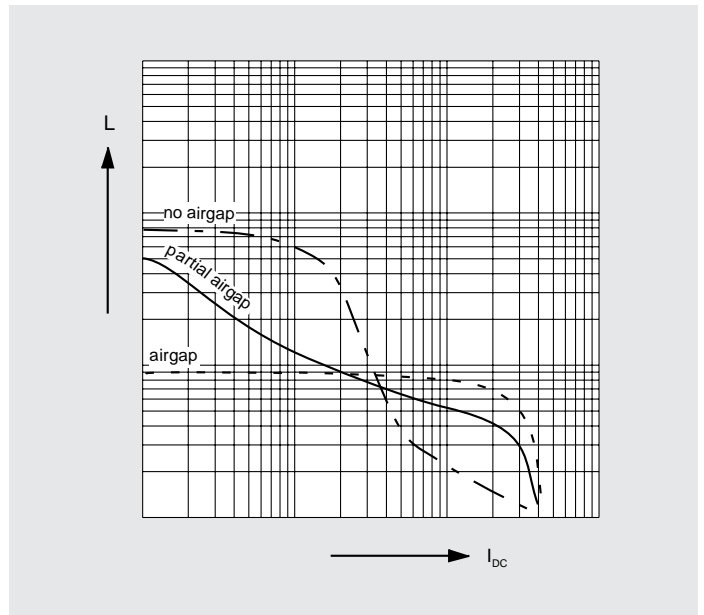
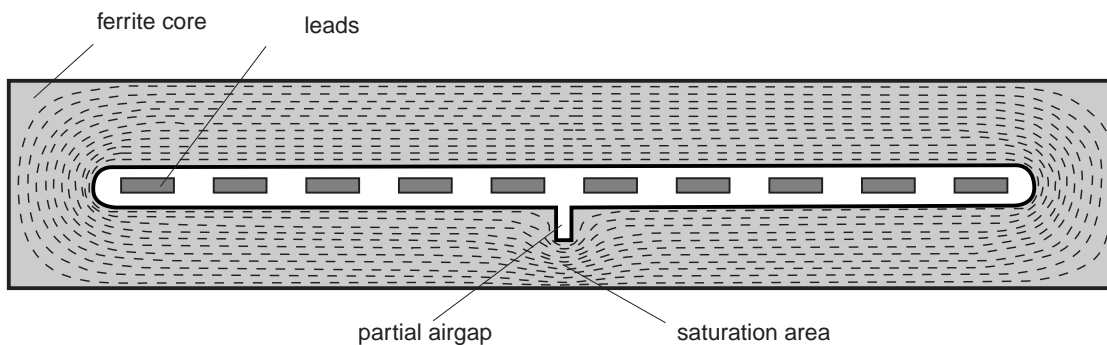

Fig.4 Inductance curve of an IIC choke with a partial airgap compared to the curves for products without and with a full airgap.



Cross-section of an IIC showing flux patterns and partial saturation.

IIC without partial airgap

This design is suitable for the following magnetic functions:

- power transformer
- signal transformer
- common-mode choke

Power transformer

IIC can perform as very flat power transformer in applications like high frequency DC/DC converters (> 500 kHz) with low voltages and low power levels. The product is best applied at low input voltages and high switching frequencies because of the limited number of turns. Although isolation voltage is specified as 500 V, the IIC10 should not be applied in AC/DC applications as safety isolation transformer. The short distance between the leads makes it unsuitable for that function. There is a trend towards converters which bring down 5 V to 3.3 V or even 2 V as supply for special IC's. Especially in the case of a bifilar winding configuration leakage flux is low and coupling satisfactory for the transformer function. At frequencies above 500 kHz the most suitable material is 3F4.

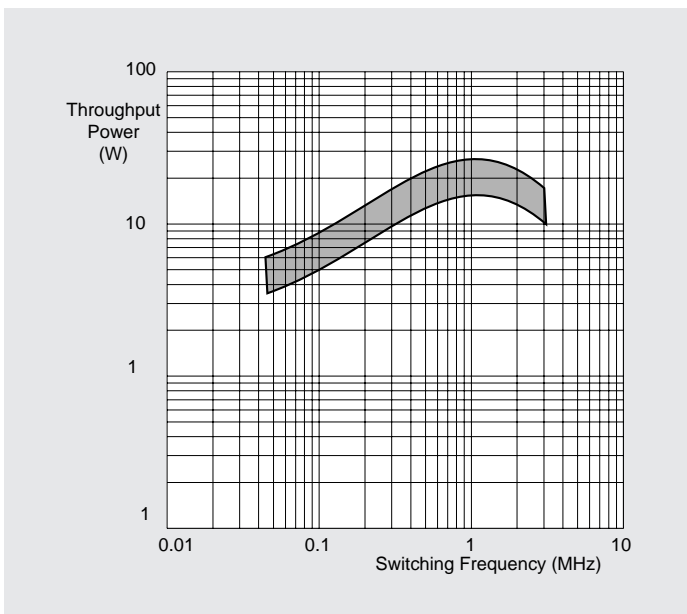

Fig.5 Throughput power capability of IIC10-14/4-3F4 when applied as a power transformer. Practical values will also depend on circuit topology and switching techniques used. Therefore only a range is indicated in the graph.

For power inductors and transformers ferrite volume is one of the major parameters determining the throughput power of the device. For this reason IIC products in power materials have a standard height of 4 mm, but can also be produced as a 3 mm high version.

Signal transformer

For signal transformers (pulse or wideband) it is important to have a high primary inductance. This level controls low frequency performance. Our high permeability material 3E6 helps to reach the required levels in spite of the low number of turns. Required low leakage inductances can be obtained by means of a bifilar winding configuration (see Fig.7 on page 6). Also in this application IIC10 is not suitable if a safety barrier is required.

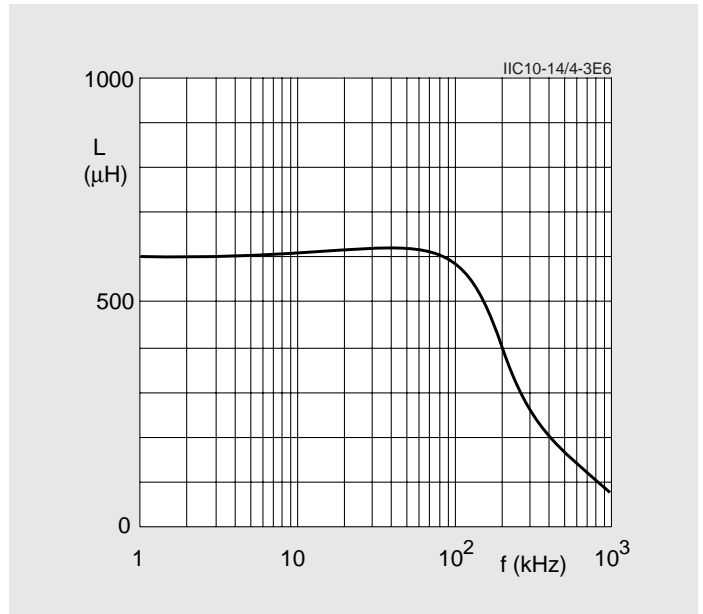

Fig.6 Inductance of IIC10-14/4-3E6 (10 turns) as a function of frequency.

Common-mode choke

Made in our top quality suppression material 3S4 or the high permeability material 3E6, the design is ideal as common-mode choke in signal or supply lines, especially if these carry large currents. The sturdy lead frame will take almost any current surge without being damaged.

All sorts of signal lines in Telecom and EDP equipment require suppression of HF noise generated by internal digital processing. Requirements are a common-mode impedance of at least 100 Ω over a very wide frequency range (10 - 1000 MHz) and, at the same time, a differential impedance of less than 10 Ω at 1 MHz to allow the real signal to pass without too much damping.

Especially with a bifilar winding configuration the coupling is excellent and differential damping will be low.

As expected 3S4 is the best material to obtain a high impedance over a wide frequency range. With 3E6 damping is already effective between 1 and 10 MHz. In combination with capacitors IIC can be effective as supply line filter also for even lower frequencies.

For common-mode chokes build height is very important since they are often used on boards together with IC's. Therefore the 3S4 product can also be made with a height of only 3mm, equal to most standard IC's.

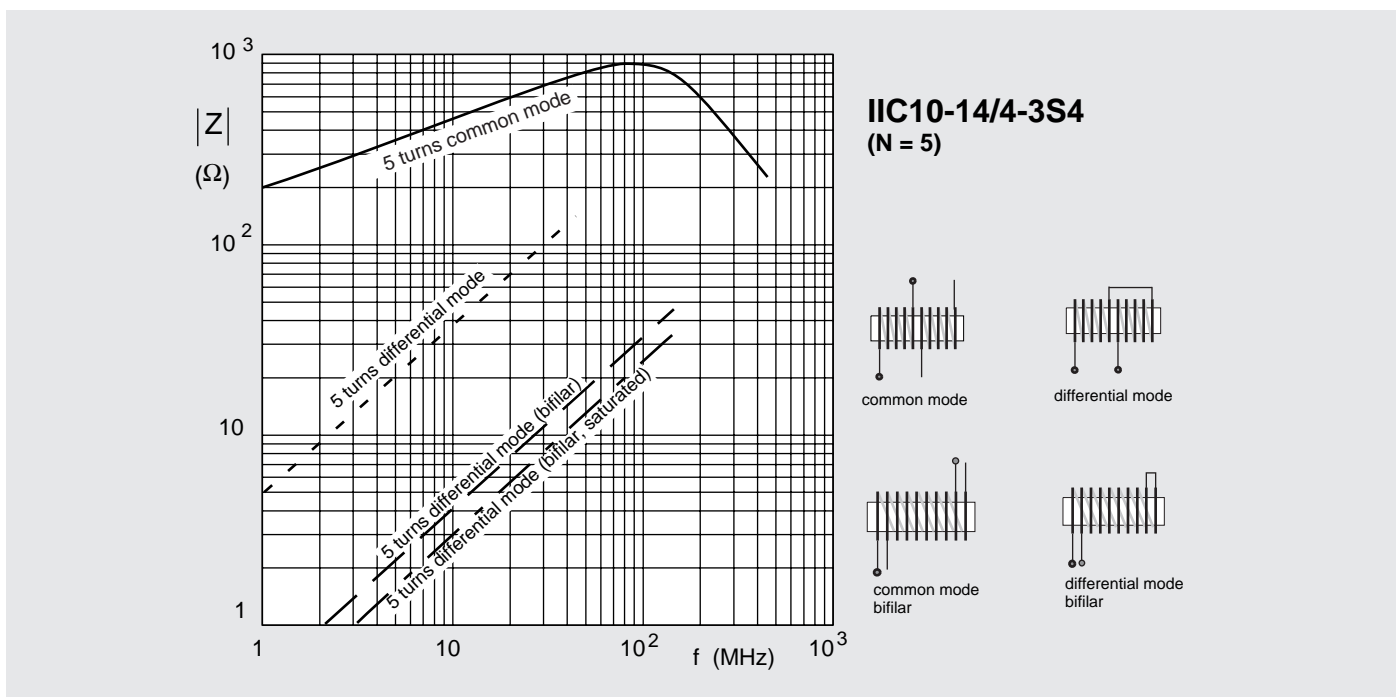

Fig.7 Impedance curves of IIC10-14/4-3S4 connected as common-mode and differential-mode choke.

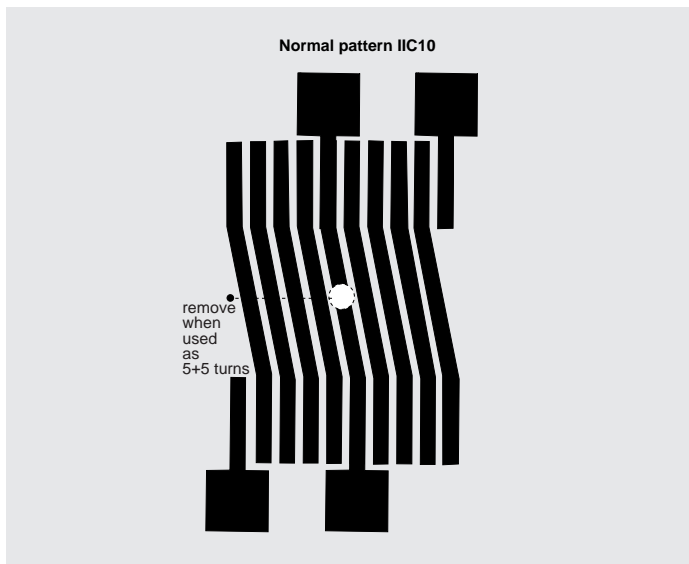

Fig.8 Unifilar recommended track pattern.

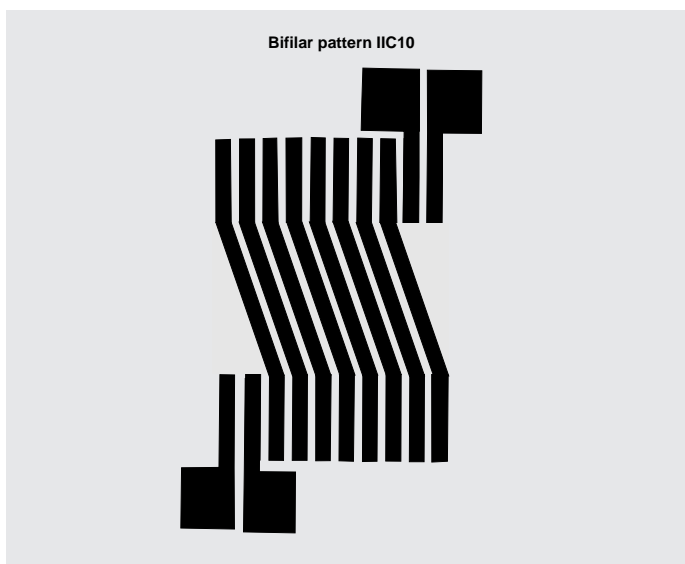

Fig.9 Bifilar recommended track pattern.

Saturable inductor

Saturable inductors can be used to regulate several independent outputs of an SMPS by blocking varying amounts of energy from the secondary of the transformer. The circuits required are both simple and economic and can be easily integrated.

Operating principles

When switch SW2 (Fig.11), representing a small transistor, is open, no reset current can flow through the winding of the saturable inductor. Because the saturable inductor has a rectangular B-H loop (see Fig. 10), the flux remains at the high level B_r even when the driving field H has fallen to zero. When switch SW1 is closed the voltage across the inductor causes a current rise in the winding. There is a short delay (t_d) because the flux rises from B_r to B_s . After that the current sharply rises to its maximum value, limited only by the load impedance.

When in the next cycle switch SW2 is closed, a reset current can flow and is regulated by the transistor. Resetting to $-H_c$, for instance, causes some extra delay (t_b) because of the larger flux swing. Full reset causes a flux swing of almost $2 \cdot B_s$, resulting in a maximum delay ($t_d + t_b$) and the blocking of a part of the energy flowing from the transformer to the load.

In this way a reset current in the order of 100 mA can regulate load currents in the order of 10 A or more, depending on the layout of the saturable inductor. For this reason the described circuit is called a magnetic regulator or even magnetic amplifier. In the case of IIC the combined resistance in leads and tracks limits the throughput current to approximately 4 A when all 10 turns are used. In many cases less turns will be needed. Then some tracks can be connected in parallel, thereby increasing the maximum current level.

The performance of the material 3R1 is comparable to that of amorphous metal making it an excellent material for application in magnetic regulators. When 3R1 cores are driven exactly at their natural mechanical resonant frequencies a magneto-elastic resonance will occur. With large flux excursions and no mechanical damping, amplitudes can become so high that the maximum tensile stress of the ferrite is exceeded. Cracks or even breakage of the core could be the result. It is advised not to use the cores at their mechanical resonant frequencies or even subharmonics (e.g. half this resonant frequency). The resonant frequency of IIC10-14/4 is approximately 180 kHz.

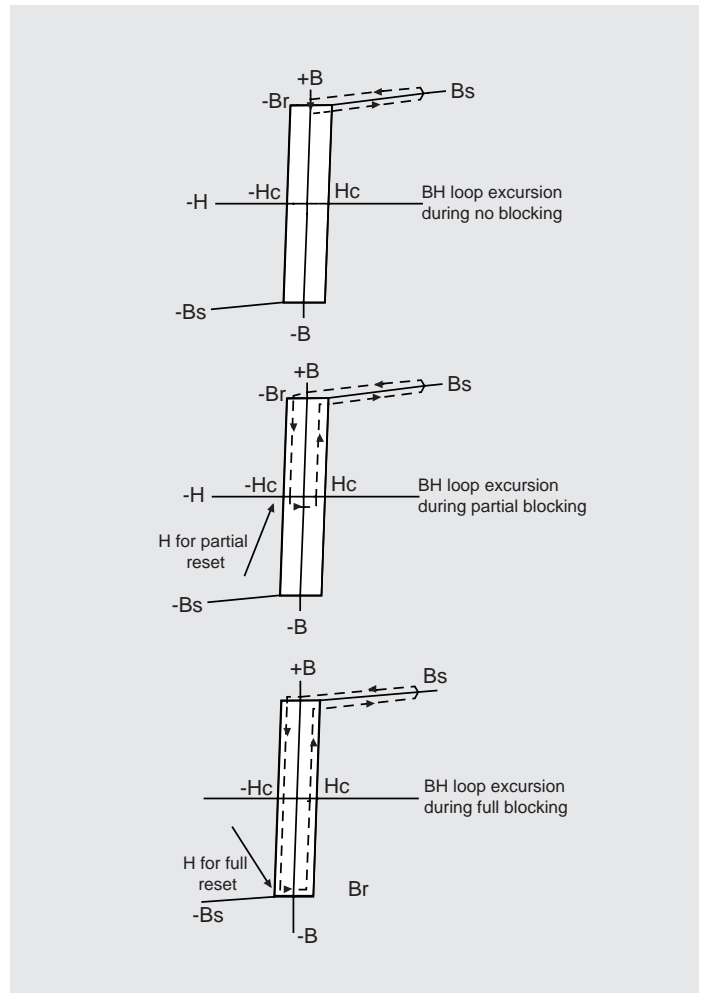

Fig.10 Schematic of flux excursions in a saturable inductor.

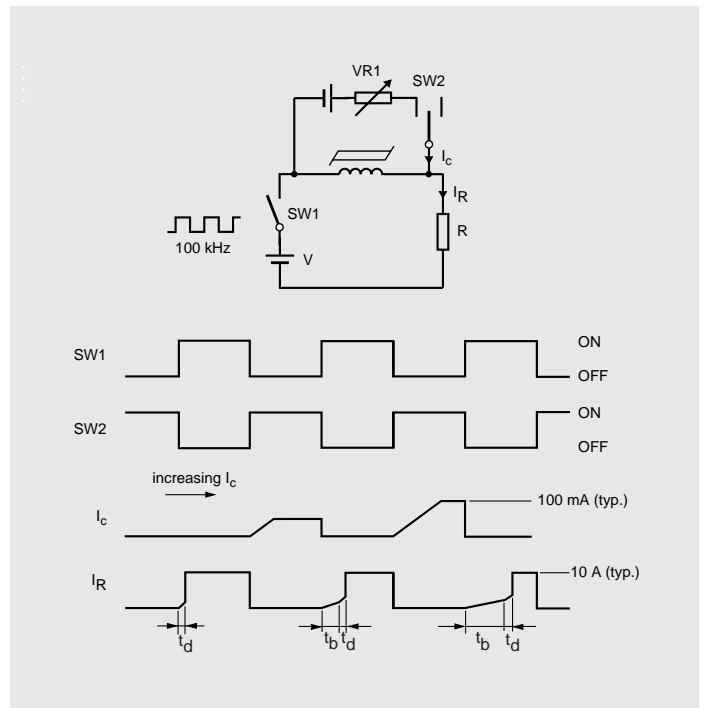

Fig.11 Schematic of a saturable inductor and associated waveforms (with regulation)

Design example

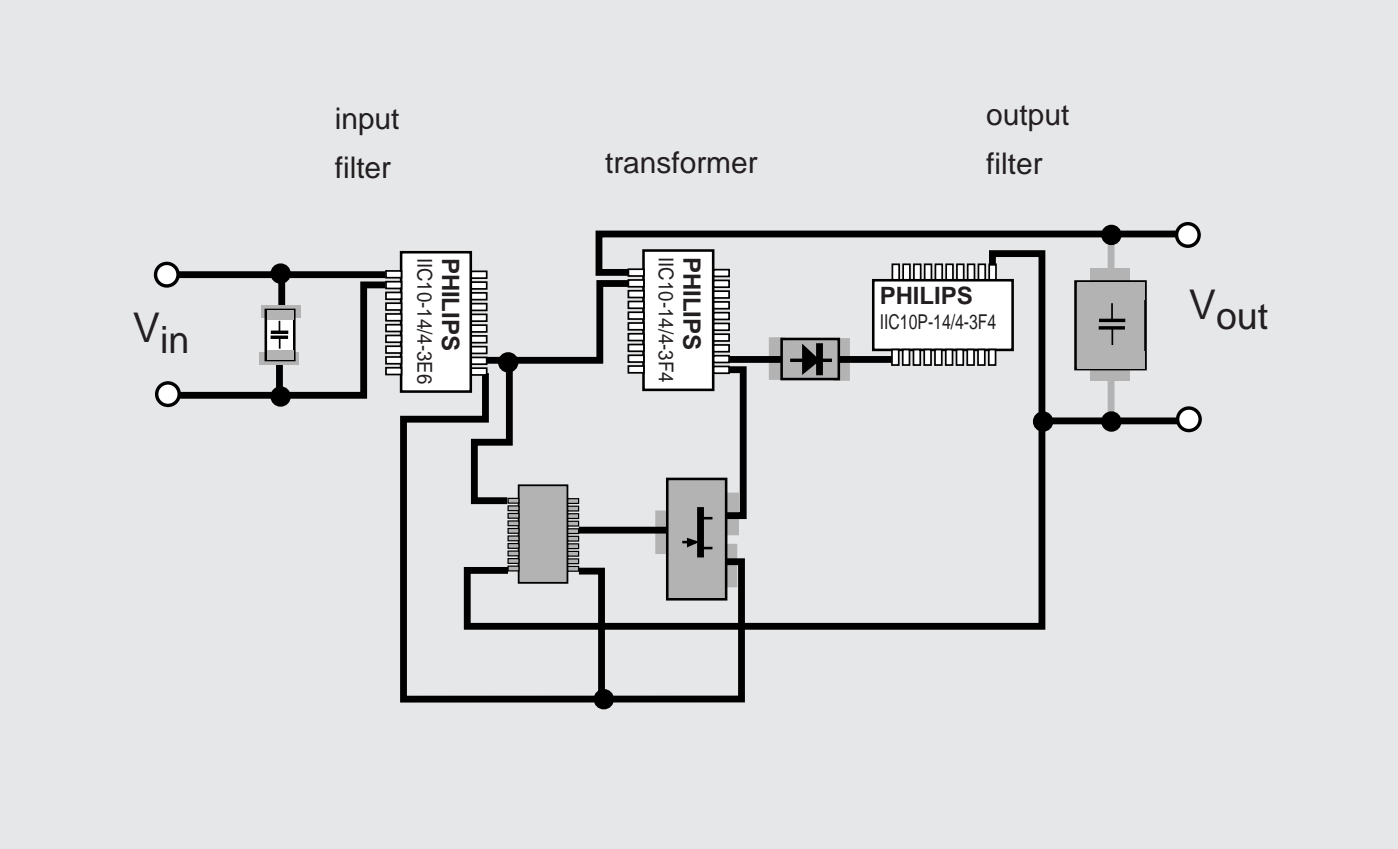
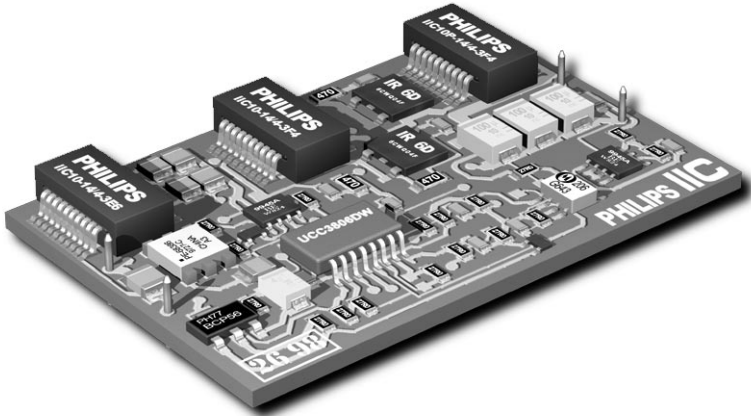

Fig.12 Basic diagram of a design example to demonstrate the versatility of the IIC concept.



For the completely worked out design of the DC/DC converter shown above, please refer to the Application Note "10 Watt DC/DC Converter using IIC Magnetics".(9398 239 03011)

Material characteristics

3C30 SPECIFICATIONS

SYMBOL	CONDITIONS	VALUE	UNIT
μ_i	25 °C; ≤ 10 kHz; 0.1 mT	1800 $\pm 20\%$	
μ_a	100 °C; 25 kHz; 200 mT	5000 $\pm 25\%$	
B	100 °C; 10 kHz; 250 A/m	≥ 370	mT
P_v	100 °C; 25 kHz; 200 mT	≤ 80	kW/m^3
	100 °C; 100 kHz; 100 mT	≤ 80	
	100 °C; 100 kHz; 200 mT	≈ 450	
ρ	DC; 25 °C	≈ 2	Ωm
T_C		≥ 240	°C
density		≈ 4800	kg/m^3

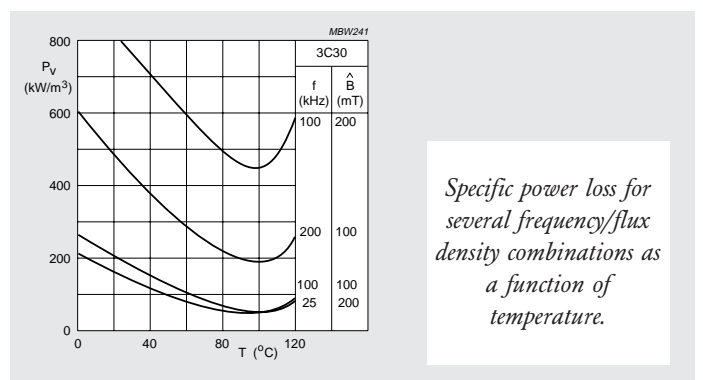
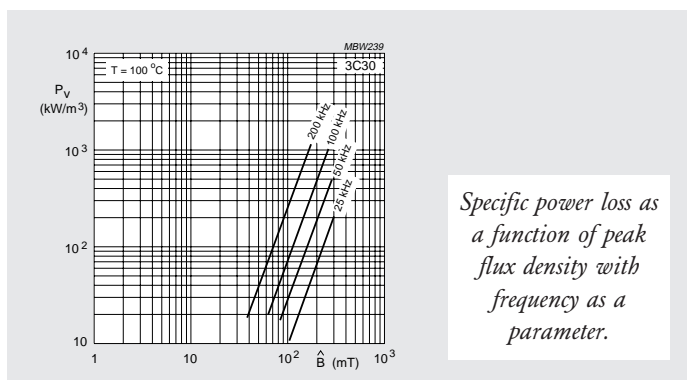
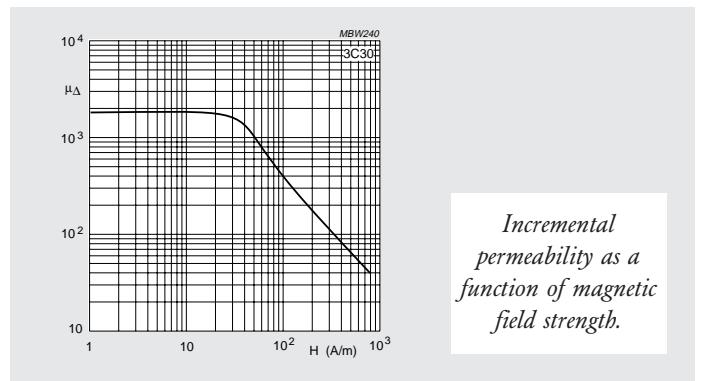
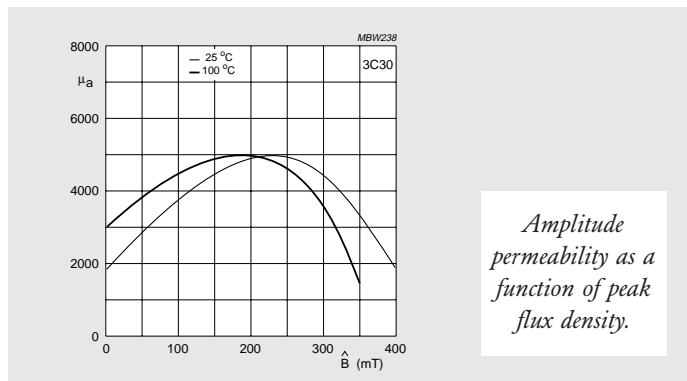
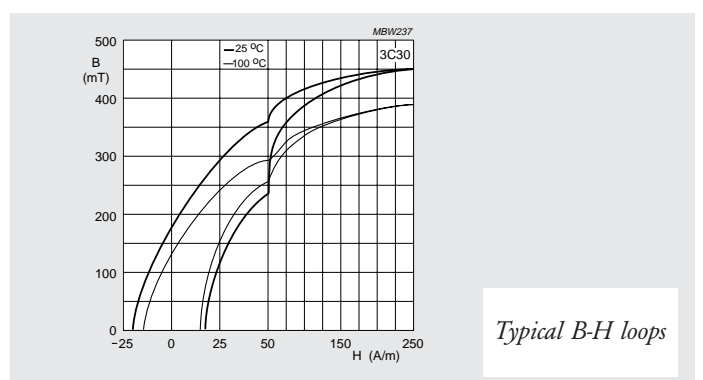
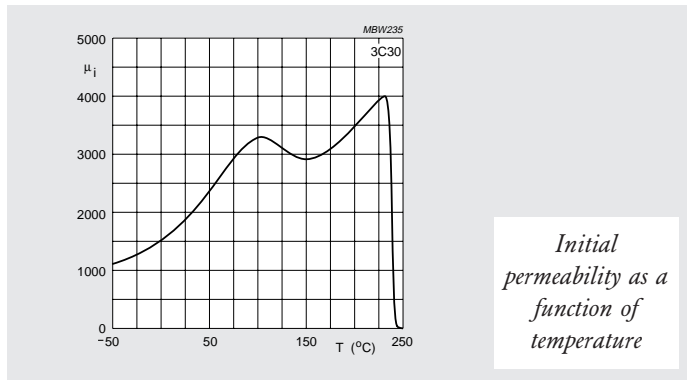
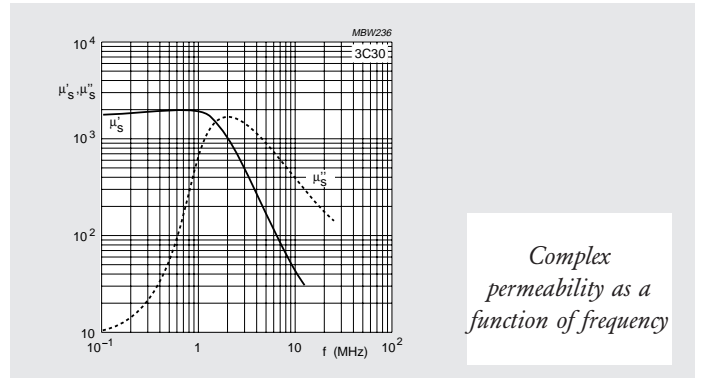

Material characteristics

3F4 SPECIFICATIONS

SYMBOL	CONDITIONS	VALUE	UNIT
μ_i	25 °C; ≤ 10 kHz; 0.1 mT	900 $\pm 20\%$	
μ_a	100 °C; 25 kHz; 200 mT	≈ 1700	
B	25 °C; 10 kHz; 250 A/m	≥ 350	mT
	100 °C; 10 kHz; 250 A/m	≥ 300	mT
P _V	100 °C; 1 MHz; 30 mT	≤ 200	kW/m ³
	100 °C; 3 MHz; 10 mT	≤ 320	kW/m ³
ρ	DC; 25 °C	≈ 10	Ωm
T _C		≥ 220	°C
density		≈ 4700	kg/m ³

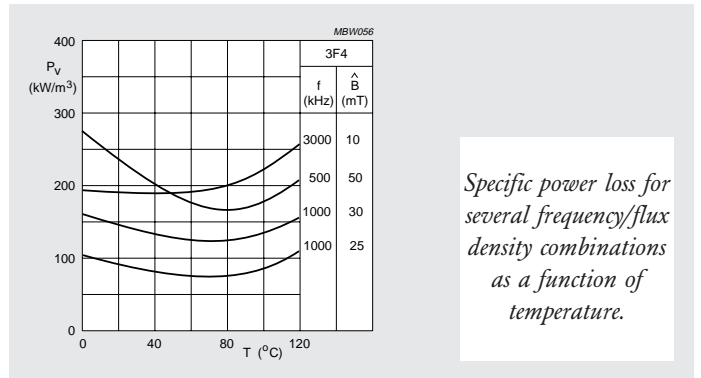
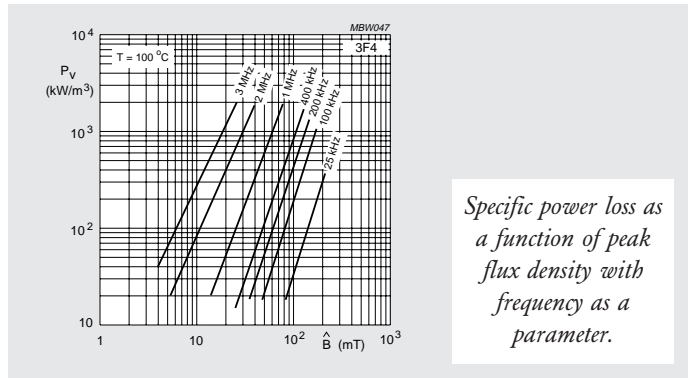
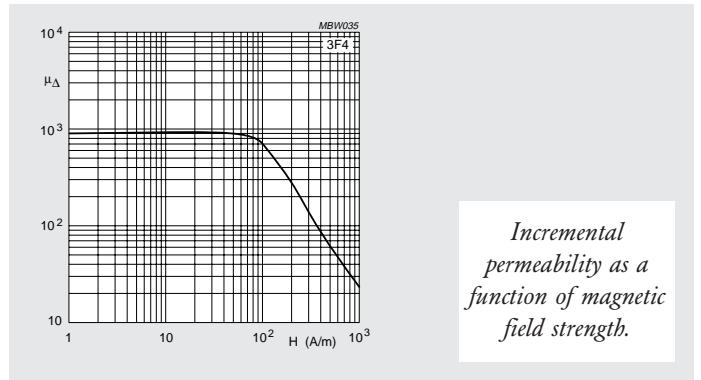
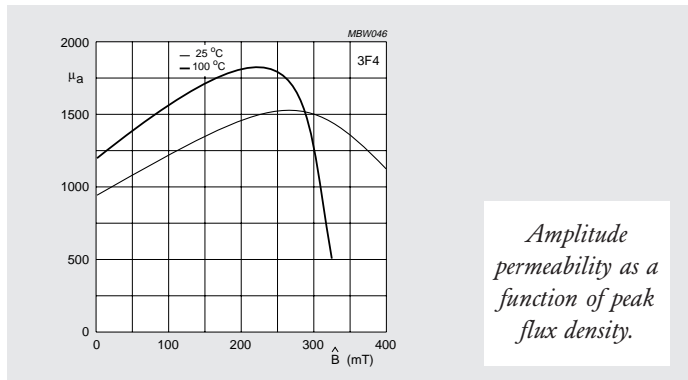
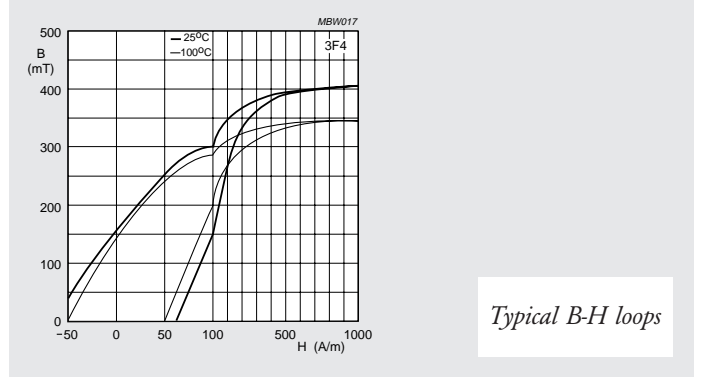
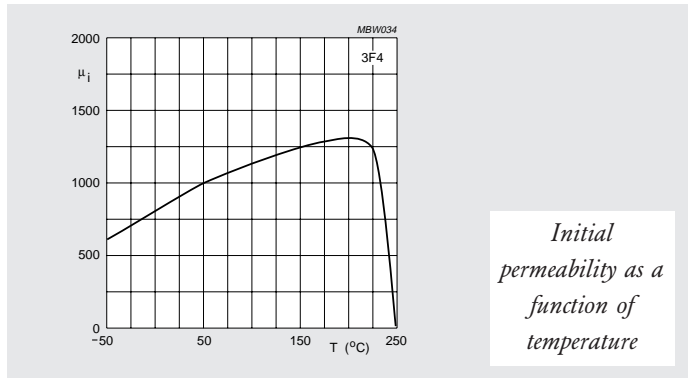
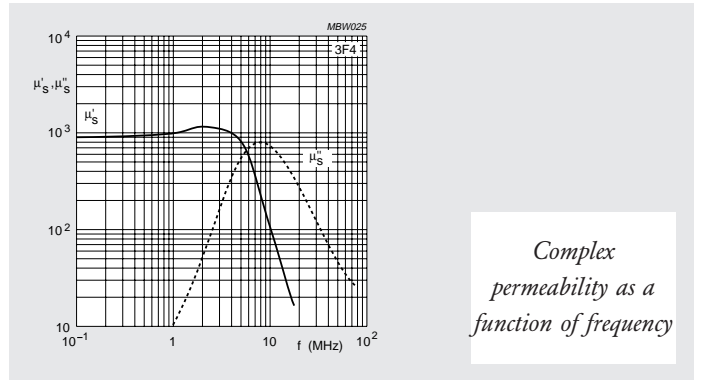

Material characteristics

3E6 SPECIFICATIONS

SYMBOL	CONDITIONS	VALUE ⁽¹⁾	UNIT
μ_i	25 °C; ≤ 10 kHz; 0.1 mT	12000 $\pm 20\%$	
B	25 °C; 10 kHz; 250 A/ m 100 °C; 10 kHz; 250 A/ m	≈ 380 ≈ 210	mT
$\tan\delta/\mu_i$	25 °C; 10 kHz; 0.1 mT 25 °C; 30 kHz; 0.1 mT	$\leq 10 \times 10^{-6}$ $\leq 30 \times 10^{-6}$	
η_B	25 °C; 10 kHz; 1.5 to 3 mT	$\leq 1 \times 10^{-3}$	T ⁻¹
ρ	DC; 25 °C	≈ 0.1	Ωm
T_C		≥ 130	°C
density		≈ 4900	kg/m ³

Note

1. Measured on sintered, non-ground ring cores of dimensions $\varnothing 14 \times \varnothing 9 \times 5$ which are not subjected to external stresses.

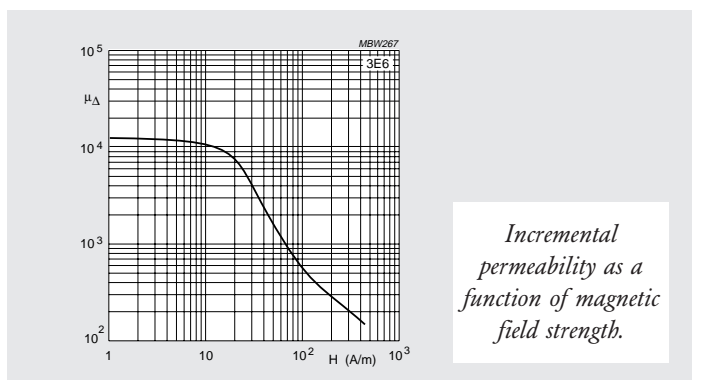
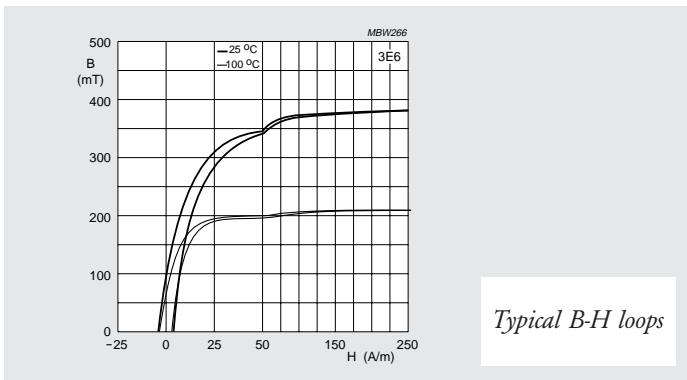
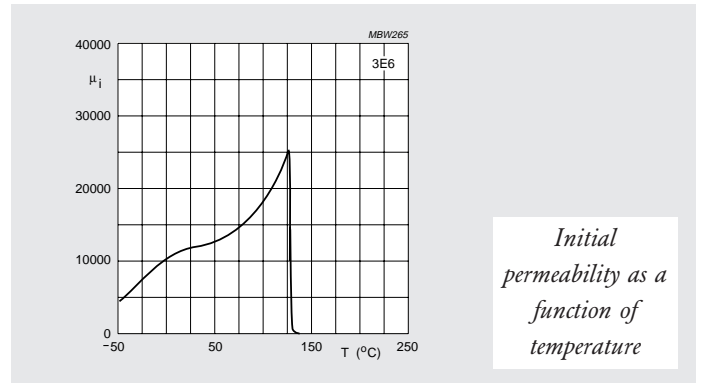
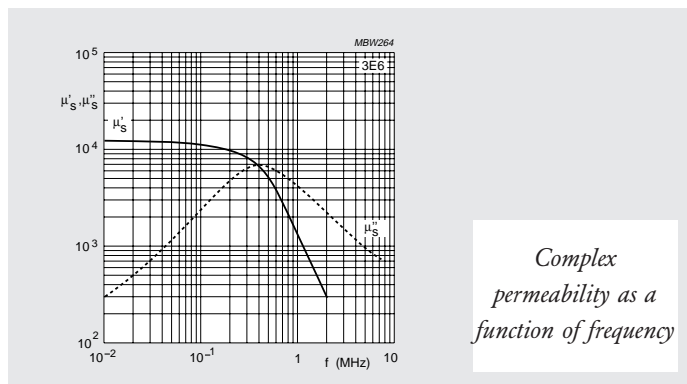

Material characteristics

3S4 SPECIFICATIONS

SYMBOL	CONDITIONS	VALUE	UNIT
μ_i	25 °C; ≤ 10 kHz; 0.1 mT	≈ 1700	
B	25 °C; 10 kHz; 250 A/ m 100 °C; 10 kHz; 250 A/ m	≈ 300 ≈ 140	mT
$ Z ^{(1)}$	25 °C; 3 MHz; 25 °C; 30 MHz; 25 °C; 100 MHz; 25 °C; 300 MHz;	≥ 25 ≥ 60 ≥ 80 ≥ 90	Ω
ρ	DC, 25 °C	$\approx 10^3$	Ωm
T_C		≥ 110	$^{\circ}\text{C}$
density		≈ 4800	kg/m^3

Note

1. Measured on a bead $\varnothing 5 \times \varnothing 2 \times 10$ mm

Remark: This wideband EMI-suppression material is optimized for applications without bias currents at moderate temperatures (e.g. common-mode chokes).

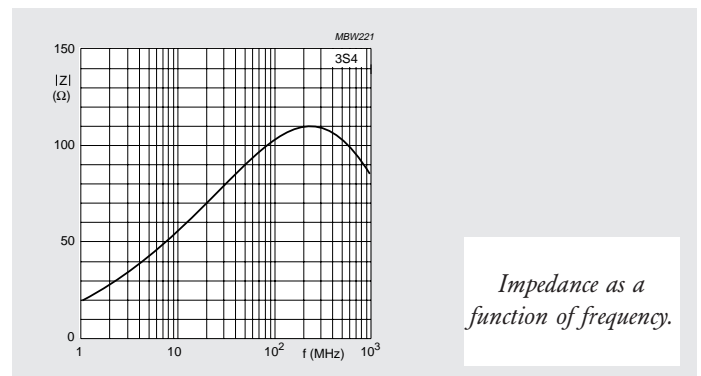
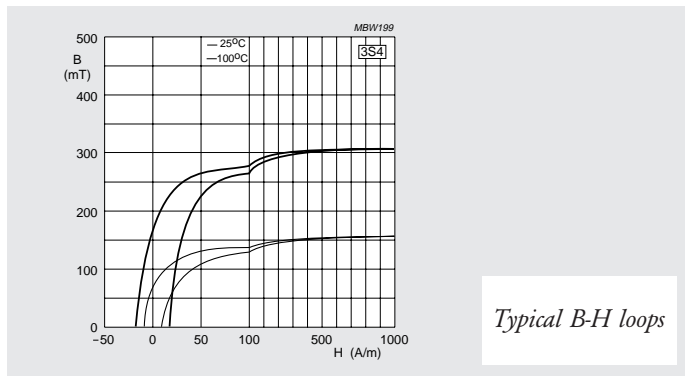
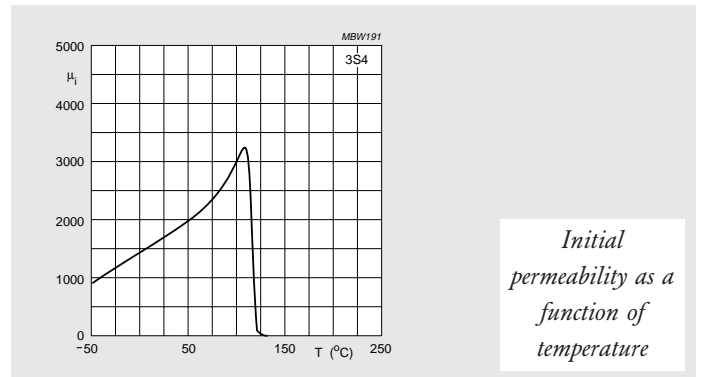
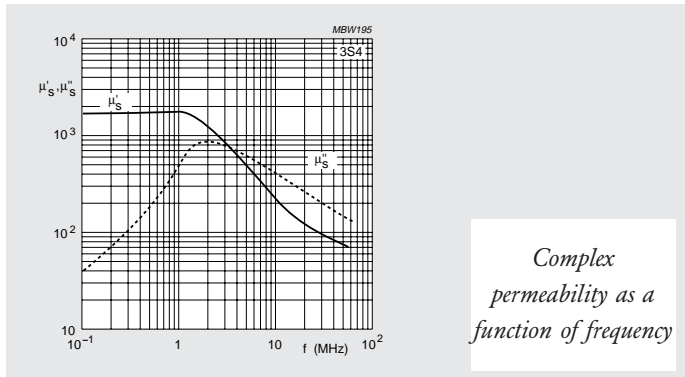

Material characteristics

3R1 SPECIFICATIONS

SYMBOL	CONDITIONS	VALUE	UNIT
μ_i	25 °C; ≤ 10 kHz; 0.1 mT	800 $\pm 20\%$	
B	25 °C; 10 kHz; 250 A/m 100 °C; 10 kHz; 250 A/m	≥ 360 ≥ 285	mT
B_r	from 1 kA/m; 25 °C from 1 kA/m; 100 °C	≥ 310 ≥ 220	mT
H_c	from 1 kA/m; 25 °C from 1 kA/m; 100 °C	≤ 52 ≤ 23	A/m
ρ	DC; 25 °C	$\approx 10^3$	Ωm
T_C		≥ 230	°C
density		≈ 4700	kg/m^3

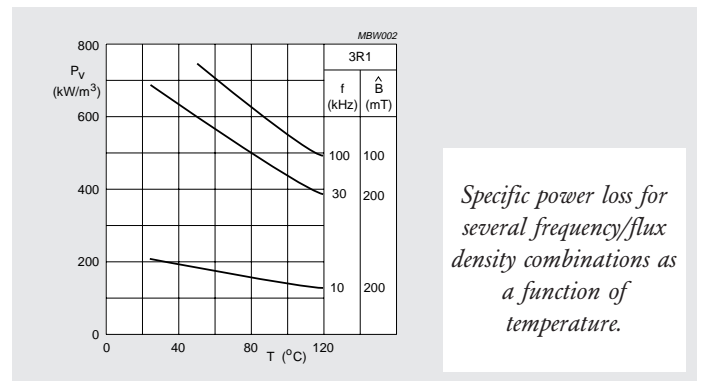
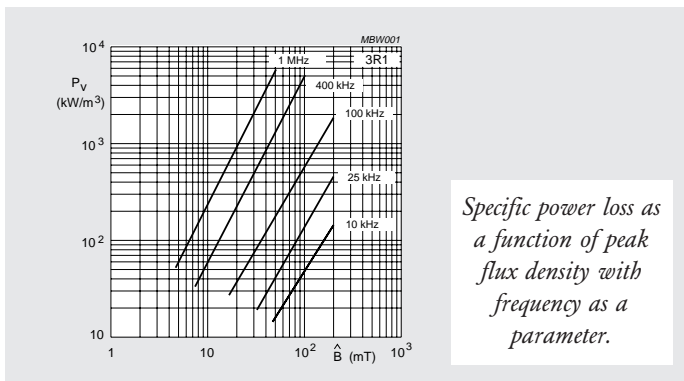
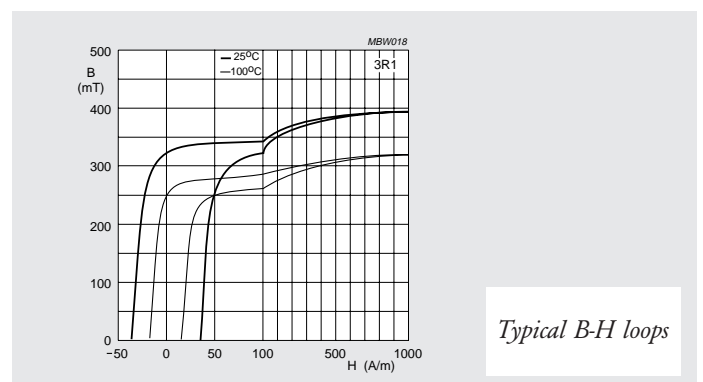
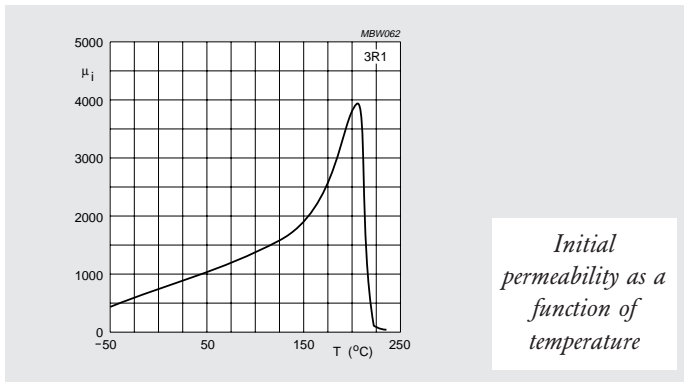
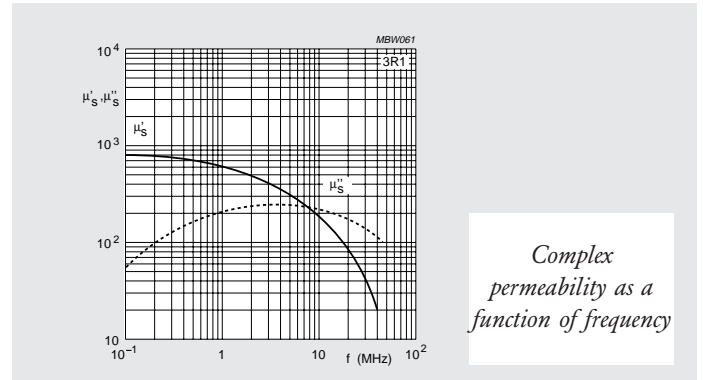

Warning:

When 3R1 cores are driven exactly at their natural mechanical resonant frequencies a magneto-elastic resonance will occur. With large flux excursions and no mechanical damping, amplitudes can become so high that the maximum tensile stress of the ferrite is exceeded. Cracks or even breakage of the core could be the result. It is advised not to drive the cores at their resonant frequencies or even subharmonics (e.g. half this resonant frequency).

Type Number structure

Type Numbers for these products consists of 3 parts:

1. Product type
2. Size (A/B)
3. Ferrite material

IIC10P - 14/4 - 3C30

1 2 3

1. Product Type

IIC: Integrated Inductive Component

10: Number of leads

P: Partial gap

2. Size A/B

A: width

B: height

Product Range

IIC10P-14/4-3C30

IIC10P-14/4-3F4

IIC10-14/4-3F4

IIC10-14/4-3E6

IIC10-14/4-3S4

IIC10-14/4-3R1



Environmental aspects

Ferrite

Our range of soft ferrites has the general composition $MeFe_2O_4$ where Me represents one or several of the divalent transition metals such as manganese (Mn), zinc (Zn), nickel (Ni), or magnesium (Mg).

To be more specific, all materials starting with digit 3 are manganese zinc ferrites based on the MnZn composition. Their general chemical formula is:

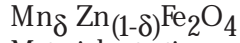

Materials starting with digit 4 are nickel zinc ferrites based on the NiZn composition. Their general chemical formula is:

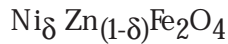

Leadframe

Leadframe material:

copper, plated with tin-lead alloy (SnPb 85/15)

Moulding material:

liquid crystal polymer (LCP), flame retardant in accordance with UL 94V-0.

General warning rules

- With strong acids, the metals iron, manganese, nickel and zinc may be partially extracted.
- In the event of fire, dust particles with metal oxides will be formed.
- Disposal as industrial waste, depending on local rules and circumstances.

General product data

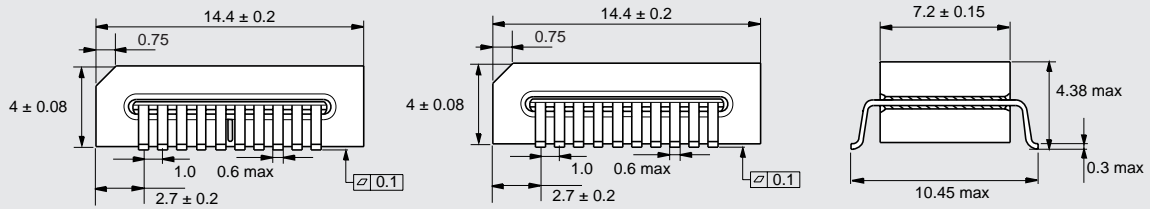

Fig.13 IIC10P-14/4 and IIC10-14/4 outline

Effective core parameters

SYMBOL	PARAMETER	VALUE	UNIT
$\Sigma(l/A)$	core factor (C1)	2.47	mm ⁻¹
V_e	effective volume	338	mm ³
l_e	effective length	28.9	mm
A_e	effective area	11.7	mm ²
m	mass	~ 1.85	g

General data

R_{dc} :

~ 65 mΩ (25°C) and ~85 mΩ (100°C) for 10 turns including 20 solder joints (assuming 70 μm Cu PCB tracks)

Leadframe material:

copper, plated with tin-lead alloy (SnPb 85/15)

Solderability:

- compatible with reflow soldering
- IEC 68-2-58, part2, test Ta, method 1

Moulding material:

liquid crystal polymer (LCP), flame retardant in accordance with UL 94V-0.

Isolation voltage:

> 500 V_{dc} between leads and between leads and ferrite core.

Isolation resistance:

>100 MΩ between leads .

Inter winding capacitance:

2 windings of 5 turns

- unifilar ~ 5 pF
 - bifilar ~ 10 pF
- (depending on track layout)

Leakage inductance:

2 windings of 5 turns

- unifilar ~ 1.8 μH
- bifilar ~ 0.2 μH

Maximum continuous current (DC):

4 A (depending on thickness of copper tracks on PCB)

Maximum peak current:

10 A

Product specification IIC10P-14/4-3C30

Electrical specification

Inductance, 10 turns, 100 kHz, no bias current:

92 $\mu\text{H} \pm 25\%$

Inductance, 10 turns, 100 kHz, bias current 1 A:

5 $\mu\text{H} \pm 25\%$

Power losses at 100 kHz, 100 mT, 100 °C:

≤ 30 mW

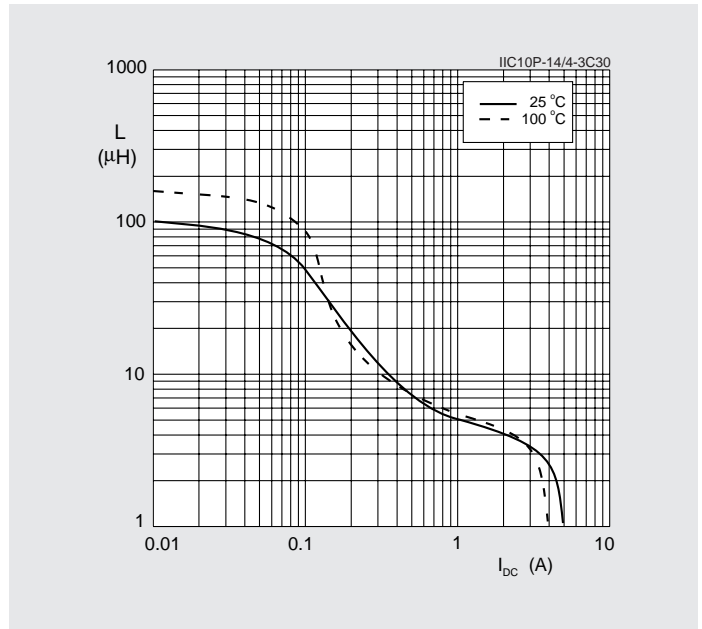

Fig14. Inductance as a function of DC-bias current of IIC10P-14/4-3C30 (partial airgap, 10 turns, 100 kHz)

Product specification IIC10P-14/4-3F4

Electrical specification

Inductance, 10 turns, 1 MHz, no bias current:

45 $\mu\text{H} \pm 25\%$

Inductance, 10 turns, 1 MHz, bias current 1 A:

5 $\mu\text{H} \pm 25\%$

Power losses at 1 MHz, 30 mT, 100 °C:

≤ 70 mW

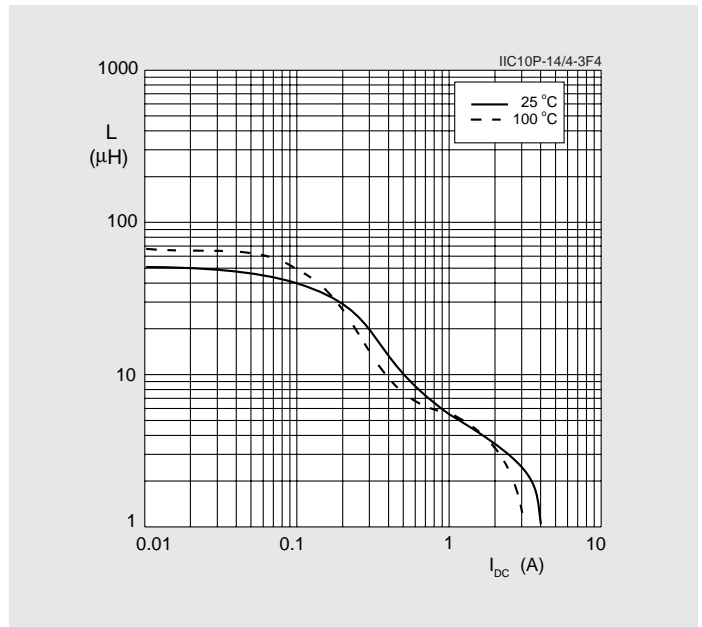

Fig15 Inductance as a function of DC-bias current of IIC10P-14/4-3F4 (partial airgap, 10 turns, 1MHz)

Product specification IIC10-14/4-3F4

Electrical specification

Inductance per line, 1 MHz, no bias current:

$0.45 \mu\text{H} \pm 25\%$

Power losses at 1 MHz, 30 mT, 100°C:

$\leq 70 \text{ mW}$

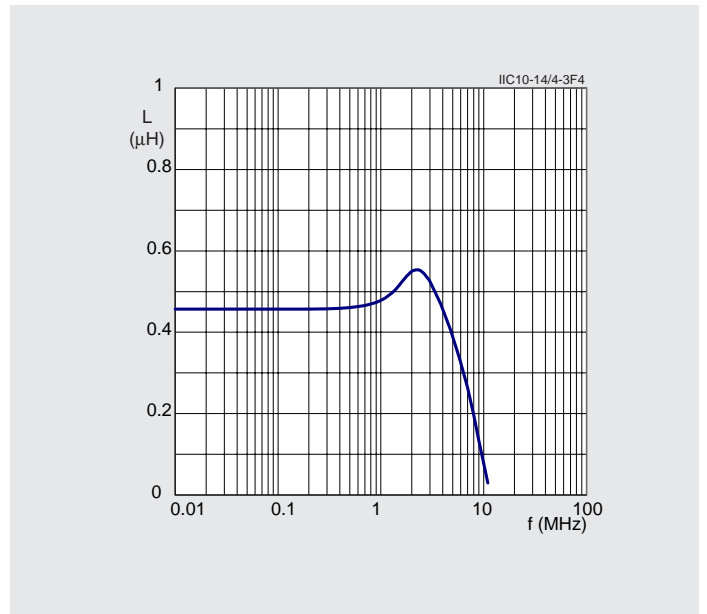

Fig.16 Inductance of IIC10-14/4-3F4 (1 turn) as a function of frequency.

Product specification IIC10-14/4-3E6

Electrical specification

Inductance per line, 10 kHz, no bias current:

$6 \mu\text{H} \pm 30\%$

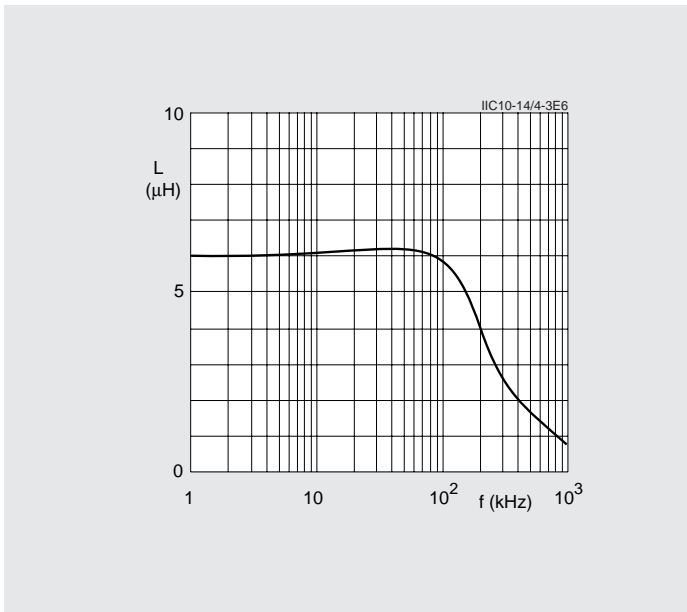

Fig.17 Inductance of IIC10-14/4-3E6 (1 turn) as a function of frequency.

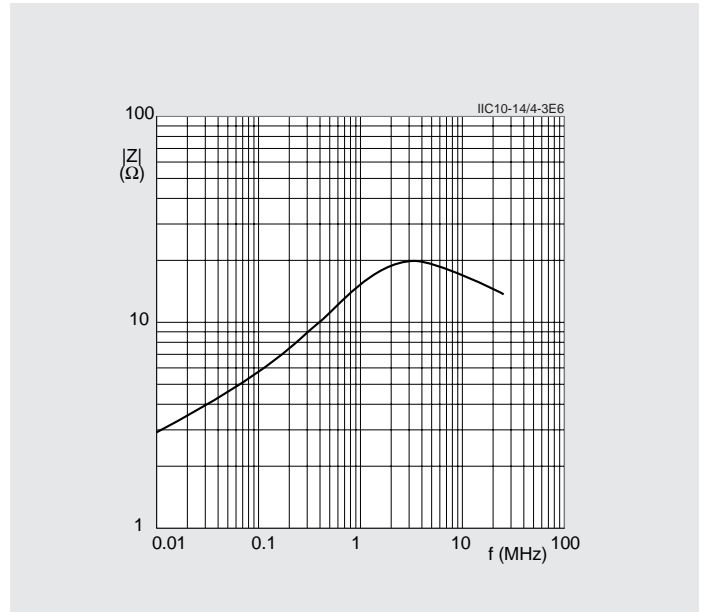

Fig.18 Impedance per lead of IIC10-14/4-3E6 (1 turn) as a function of frequency.

Product specification IIC10-14/4-3S4

Electrical specification

Typical impedance per line at 100 MHz:

$$Z_{\text{typ}} \sim 35 \Omega$$

Minimum guaranteed value is typical -20%

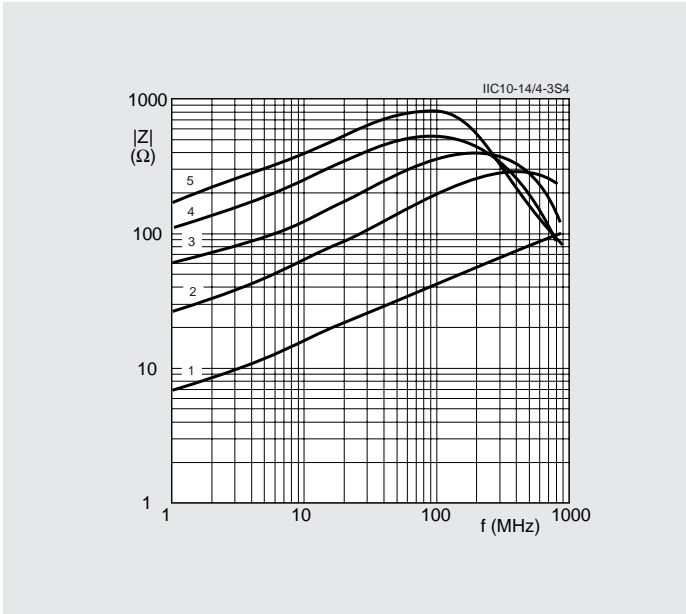

Fig.19 Impedance curves of IIC10-14/4-3S4 with the number of turns as a parameter.

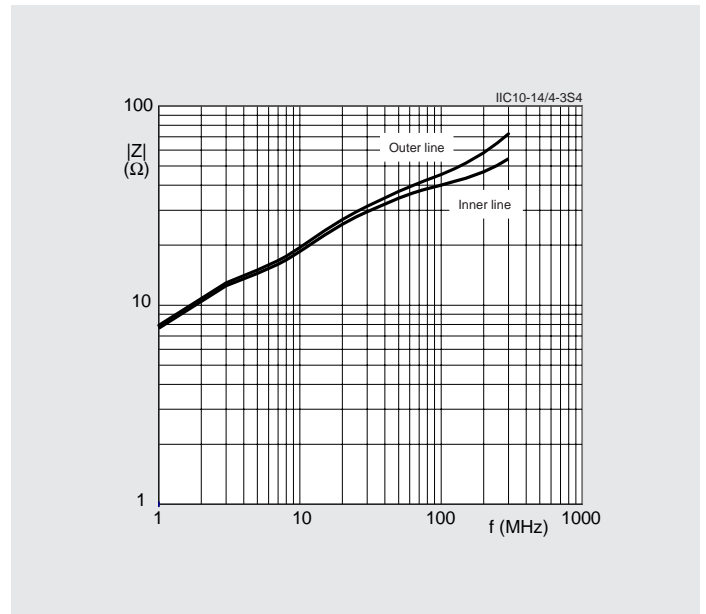

Fig.20 Impedance curves of IIC10-14/4-3S4 for a single inner and outer lead.

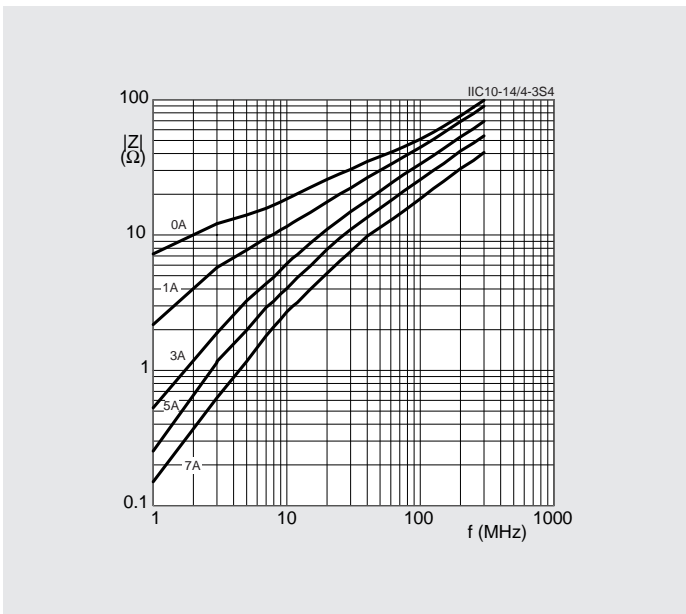

Fig.21 Impedance curves of IIC10-14/4-3S4 for a single outer lead with bias current as a parameter.

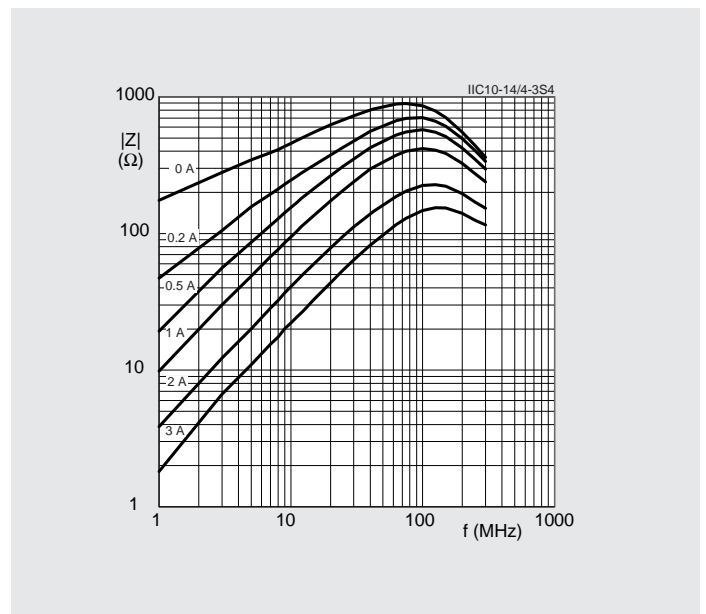

Fig.22 Impedance curves of IIC10-14/4-3S4 for 5 turns with bias current as a parameter.

Product specification IIC10-14/4-3R1

Electrical specification

E · t product at 100 kHz, 800 A/m, 100 °C and 10 turns:

$\geq 33 \text{ V} \cdot \mu\text{s}$ with a reset current of 70 mA.

$\leq 12 \text{ V} \cdot \mu\text{s}$ with a reset current of 0 mA.

The maximum current handling capacity of this product is mainly controlled by the heat dissipation in the copper tracks on the PCB. Therefore no absolute value can be specified.

Fig. 23 shows the thermal behaviour of an IIC10 on different PCB's with 10 turns connected. Most magnetic regulator applications require less turns, for instance 7. In that case 3 turns of IIC10 and of the PCB tracks can be placed in parallel, which results in a decrease of the total resistance to almost half the original value. An optimized track layout is shown in Fig.24. The effect on temperature rise on a 70 μm PCB is shown in Fig. 25.

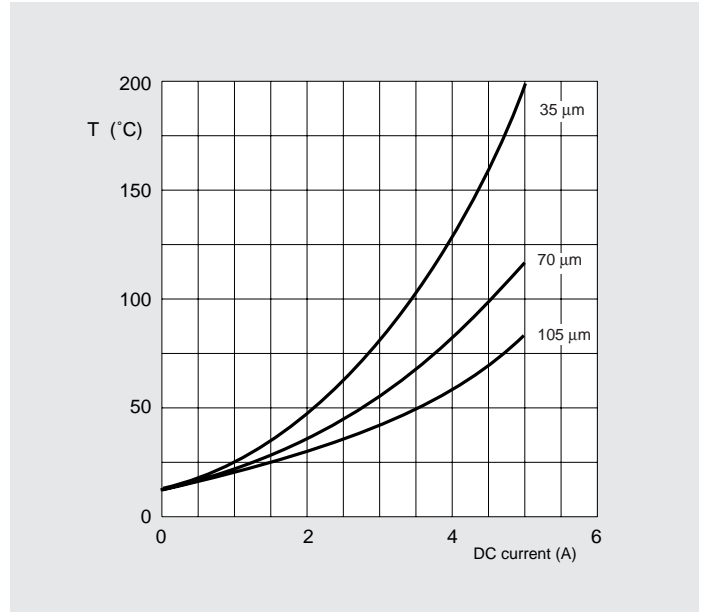

Fig.23 Temperature of IIC10-14/4-3R1 (10 turns) as a function of DC current with PCB copper layer thickness as a parameter.

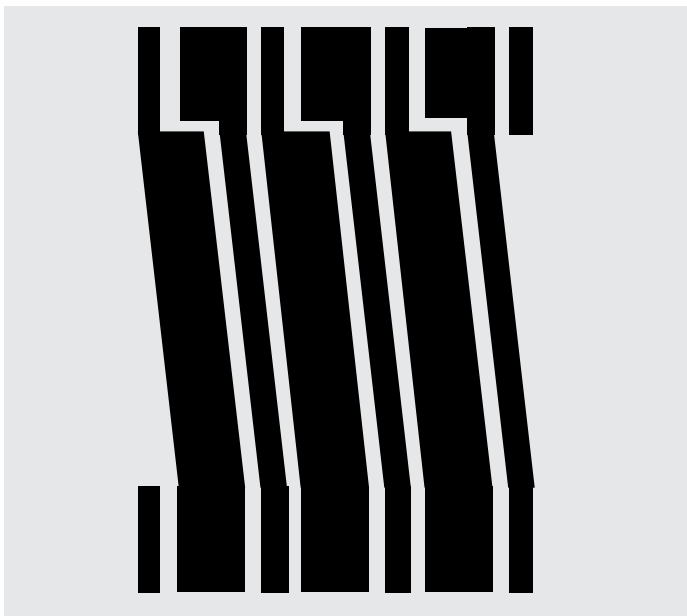

Fig.24 Proposed low resistance PCB track layout for 7 turns.

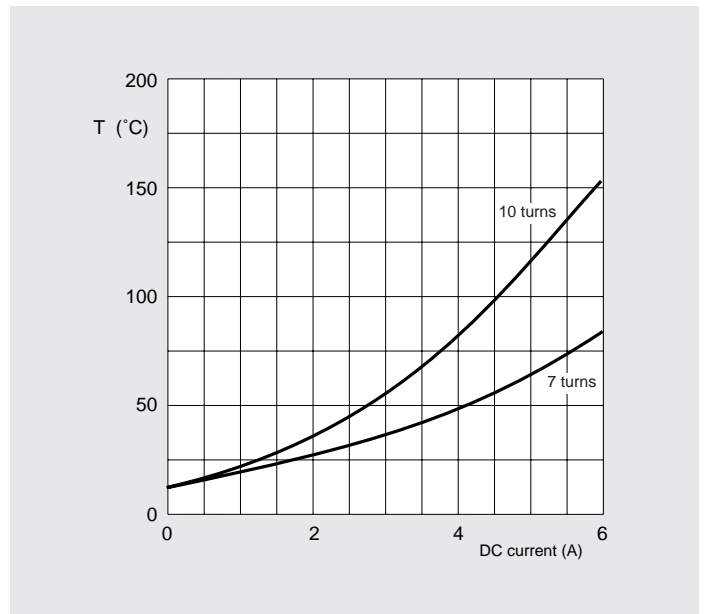

Fig.25 Temperature of IIC10-14/4-3R1 on a 70 μm PCB as a function of DC current with the number of turns as a parameter.

Reliability and Quality Controls

PHILIPS COMPONENTS IIC's are submitted to extensive tests to ensure high quality, high reliability and complete customer satisfaction. A survey is given below.

TEST	IEC NORM / REFERENCE	CONDITIONS
A. Climatic non operational & non packed		
(1) Cold	IEC 68-2-1 Ab	96 hours at -25°C
(2) Dry Heat	IEC 68-2-2 Bb	96 hours at +110°C
(3) Damp Heat (cyclic)	IEC 68-2-30 Db	21 days between +25 and +40°C at 95% RH
(4) Damp Heat (steady state)	IEC 68-2-30 Ca	21 days at +40°C and 93%RH
(5) Thermal Cycling	IEC 68-2-14 Nb	5 cycles between -55°C and +150°C
B. Mechanical non operational & non packed		
(6) Vibration (sinusoidal)	IEC 68-2-6 Fc	frequency range 10-55-10 Hz amplitude 0.35 mm - 3 axis 30 minutes per axis
(7) Bump	IEC 68-2-29 Eb	peak acceleration: 245 m/s ² (25 g) number of bumps: 1000 per direction number of directions: 6
(8) Shock	IEC 68-2-27 Ea	duration of pulse: 11 ms pulse shape: half-sine number of directions: 6 number of shocks: 3 per direction peak acceleration: 490 m/s ² (50 g)
(9) Robustness of Terminations	IEC 68-2-20 Ub	method 1
(10) Resistance to Soldering Heat	IEC 68-2-20 Tb	method 1A 5 ± 1 sec at 260 ± 5°C
(11) Solderability	IEC 68-2-20 Ta (no extra aging e.g 15 hours at 155°C)	first part method 1 2 ± 0.5 sec at 235 ± 5°C
(12) Flammability	UL 94	V0 (0.81 mm)
Requirements after Tests		
<u>Test</u>	<u>Electrical</u> (change L)	<u>Mechanical</u>
(1)	≤ 5%	no changes
(2)	≤ 5%	no changes
(3)	≤ 5%	no changes
(4)	≤ 5%	no changes
(5)	≤ 5%	no changes
(6)	≤ 5%	no changes
(7)	≤ 5%	no changes
(8)	≤ 5%	no changes
(9)		no changes
(10)		no changes
(11)		≥ 95% wetted surface

Soldering

The advantages of good solderability of both components and substrate can be summarized as follows:

1. Lower soldering temperatures and shorter dwell times prevent damage to devices or dissolution of metallization. The thickness of inter-metallic zones is minimized, thus increasing mechanical integrity and providing a stable electrical connection.
2. It permits the use of a less active flux. Therefore the flux residue activity is low and cleaning the substrate may be unnecessary.

3. Better cost effectiveness by shorter production times owing to less re-working and repairs.

PHILIPS COMPONENTS Integrated Inductive Components are suitable for reflow soldering. Recommended temperature profiles for both methods are given below.

For repairing soldered joints, recommended settings 350°C, within 5 seconds.

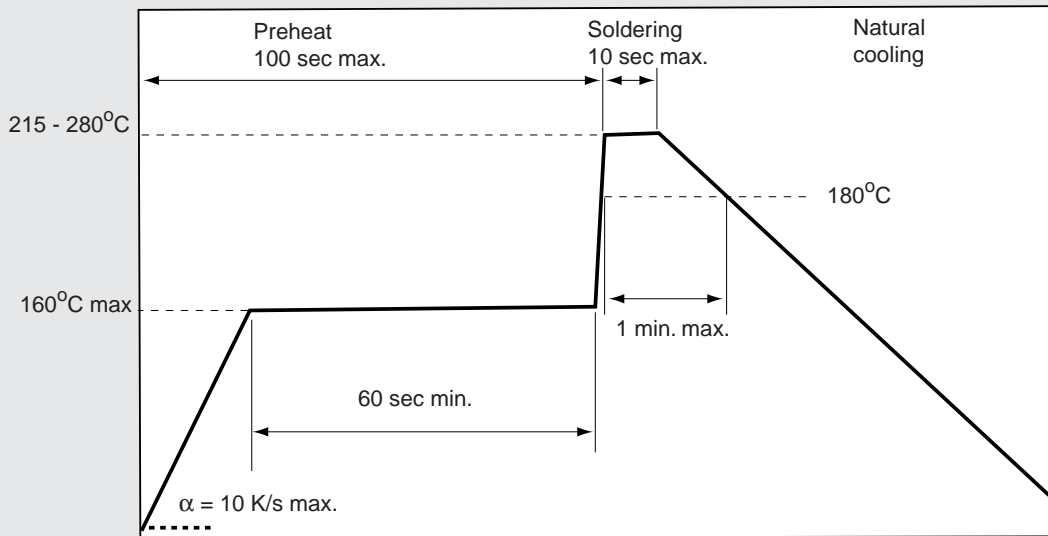

Fig.26 Recommended temperature profile for reflow soldering.

Recommended solder lands

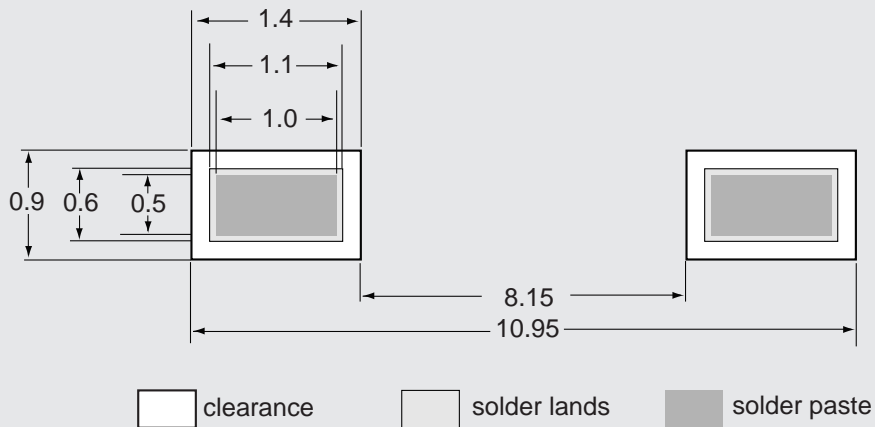

Fig.27 Recommended solder lands.

Packing

PHILIPS COMPONENTS IIC's are delivered taped and reeled, ready for use in automatic pick-and-place machines, according to IEC 286-B and EIA 481-2.

Reel

Reels size is 330mm (13 inch), with approximately 1000 products.

Packing quantities

SIZE	PACKING QUANTITY
IIC10-14/4	1000
IIC10P-14/4	1000

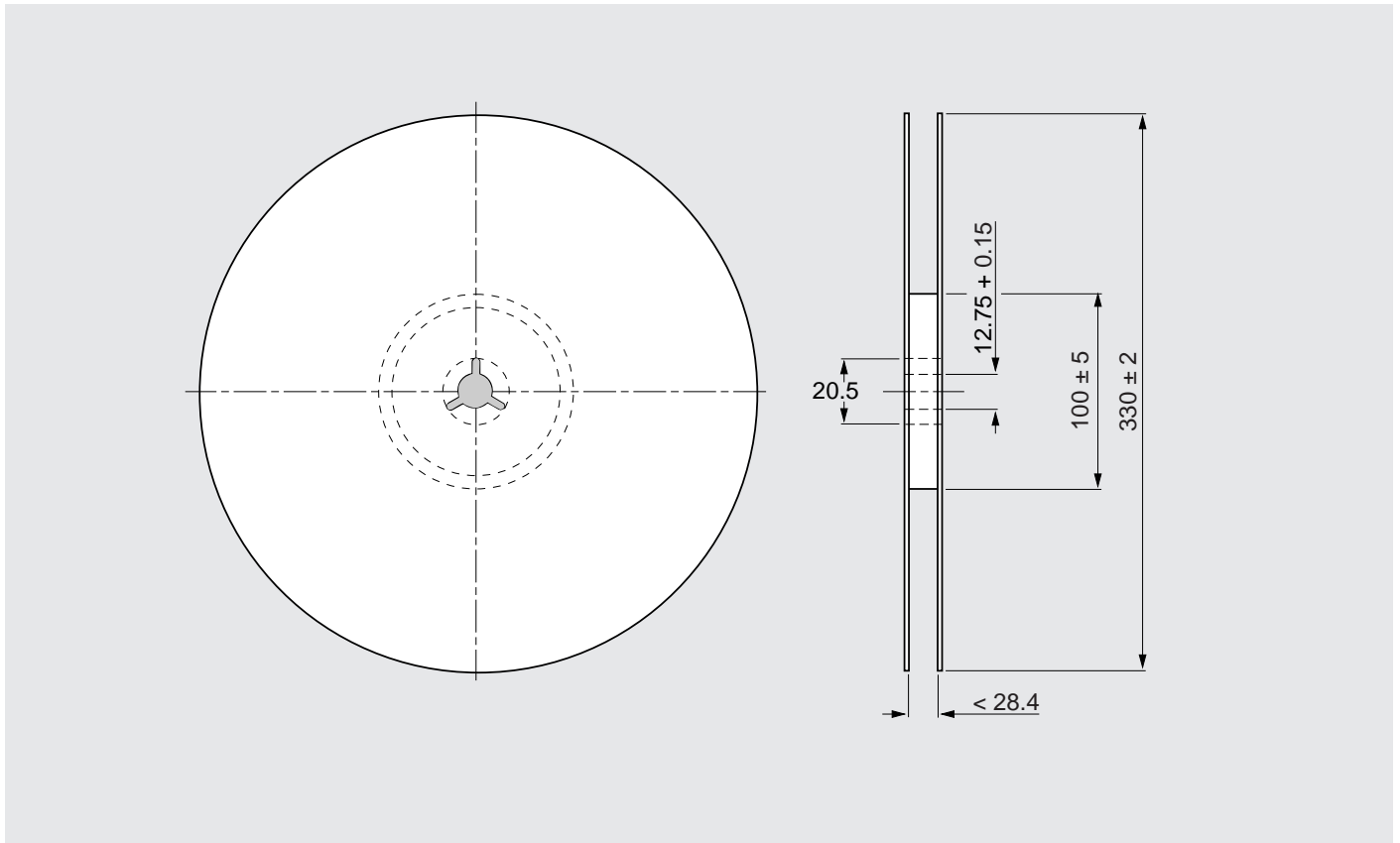

Fig.28 Dimensions of reel

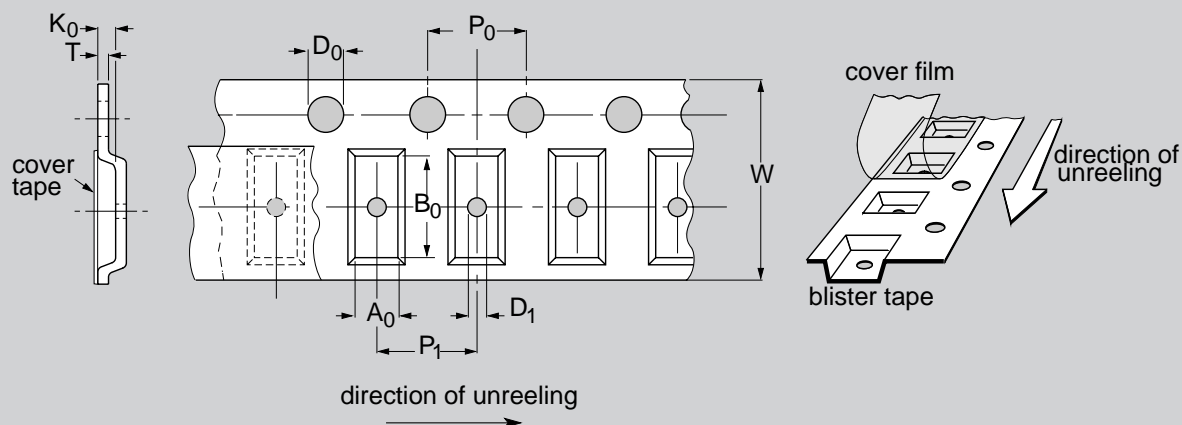

Fig29. Dimensions of blister tape

SIZE	A_0	B_0	W	T	D_0	D_1	P_0	P_1	K_0
IIC10-14/4	10.6 ± 0.1	14.75 ± 0.1	24 ± 0.3	0.3	1.5 ± 0.1	1.5 ± 0.25	4.0 ± 0.1	12 ± 0.1	4.75 ± 0.1

Storage requirements

Storage requirements advised here should be observed in order to ensure the soldering of the exposed electrode:

- Maximum ambient temperature shall not exceed 40°C. Storage temperature higher than 40°C could result in deformation of packaging materials.
- Maximum relative humidity recommended for storage is 70%. High humidity with high temperature can accelerate the oxidation of the tin-lead plating on the termination and reduce the solderability of the components.
- Products shall not be stored in environments with the presence of harmful gases containing sulfur or chlorine.

